

acmaglev.1

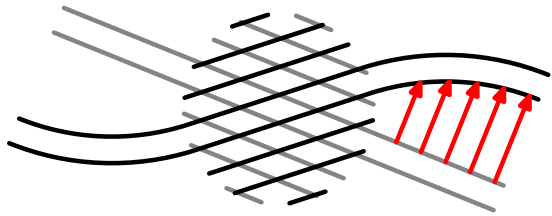

acoplanv.1

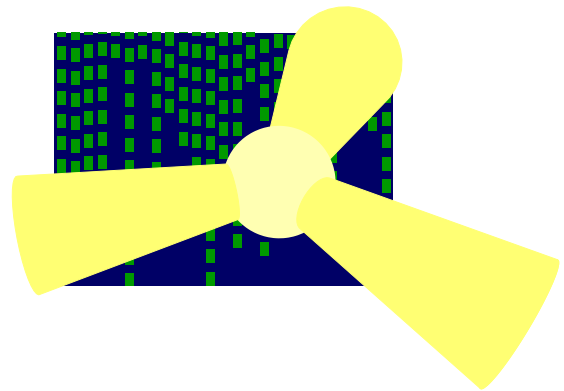

aledlogo.2

All great ideas end-up being

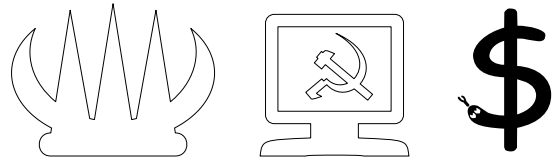

distorted by Human Nature

allgreatideas.1



ahoraesglobal.1

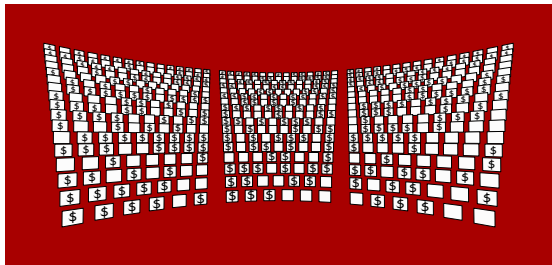

aledlogo.1

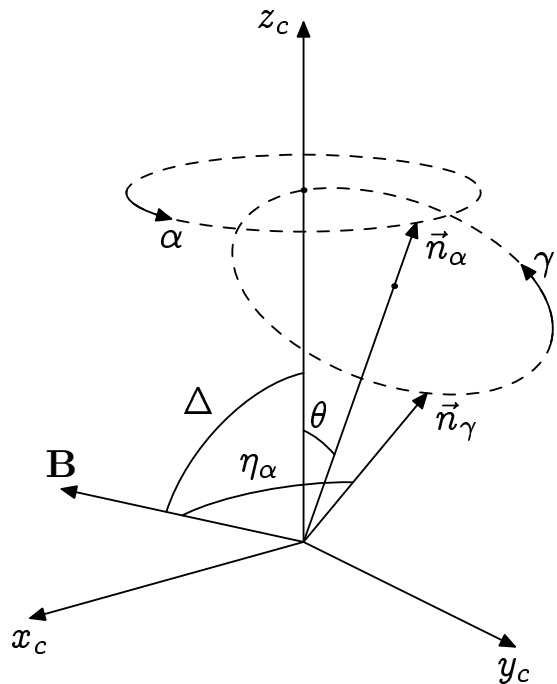

anglinerigorouscircle.1

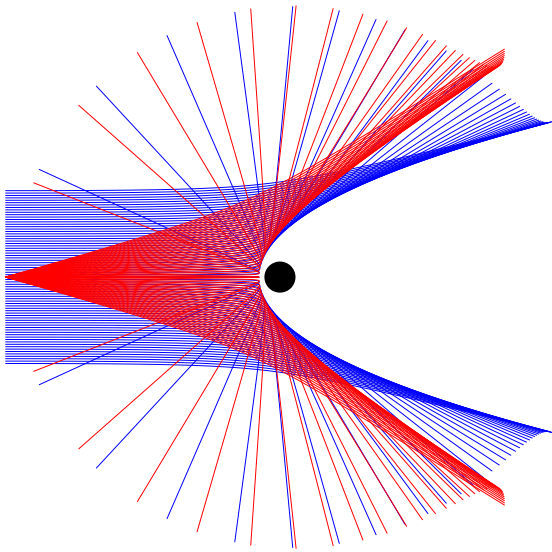

antimattermeteor.1

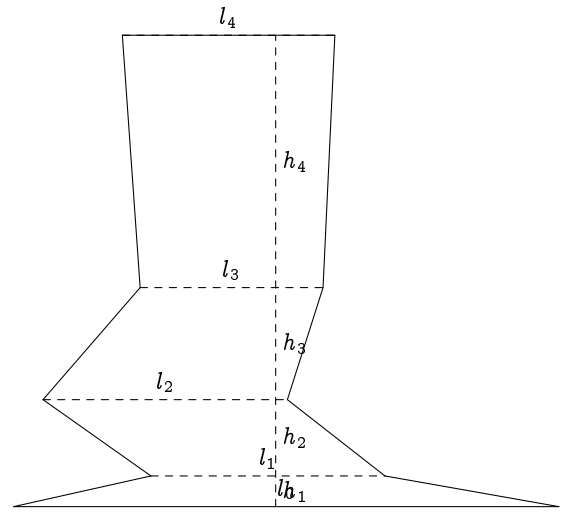

avalzero.2

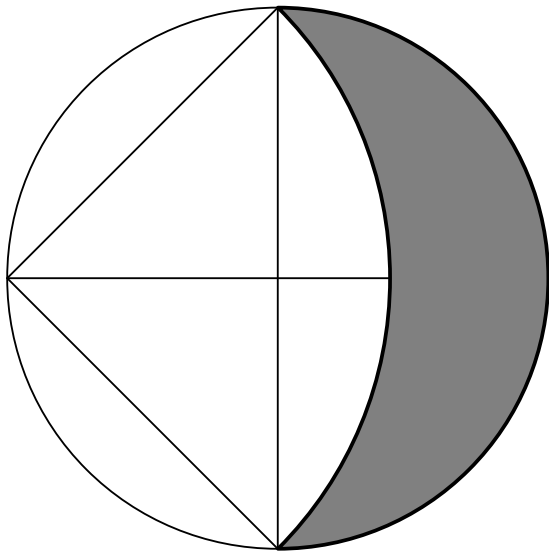

avalzero.1

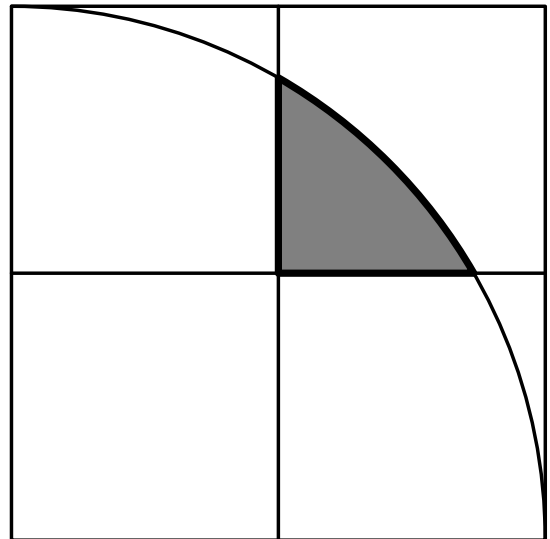

avalzero.3

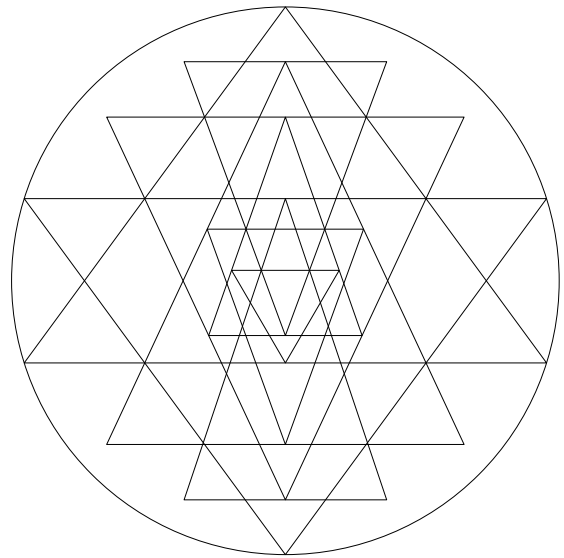
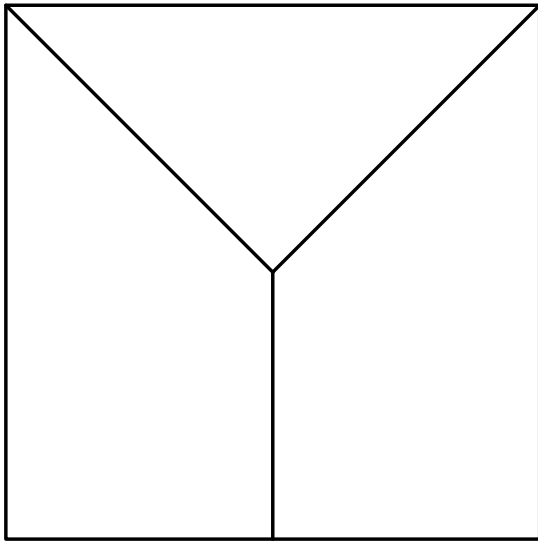

badshreeyantra.1

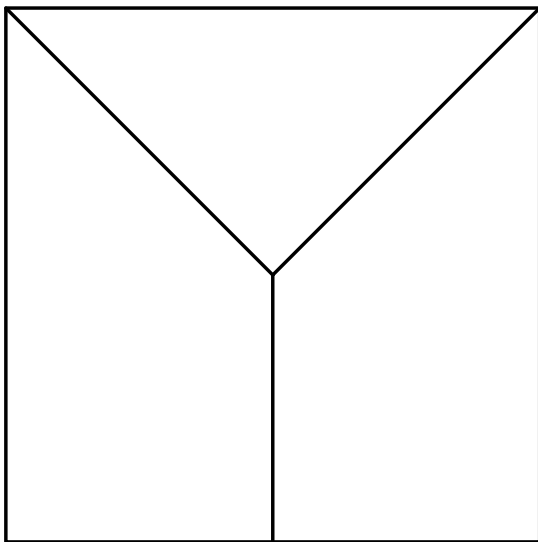

avalzero.4

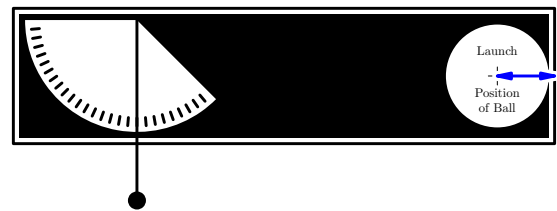

balllauncher.0

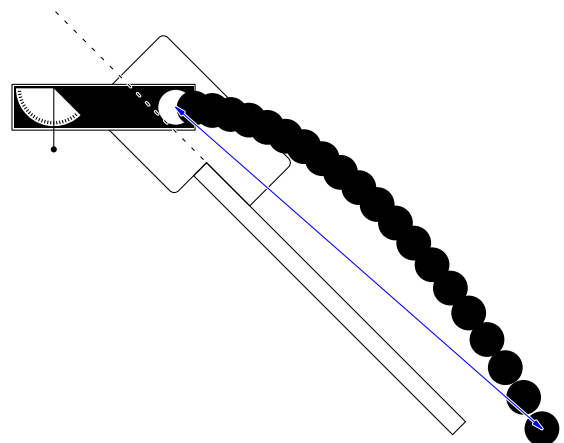

balllauncher.9

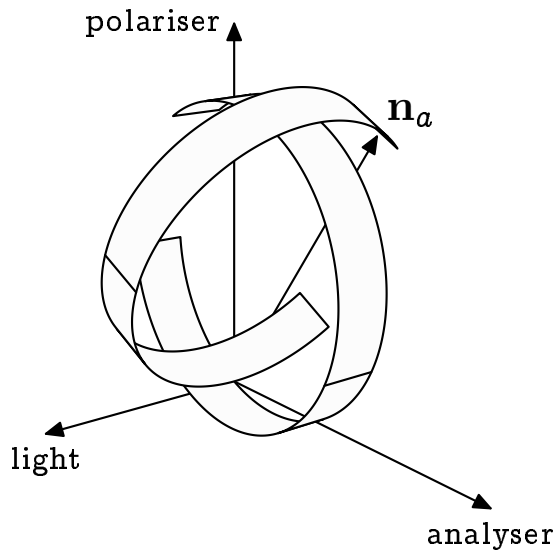

bananadimmer.1

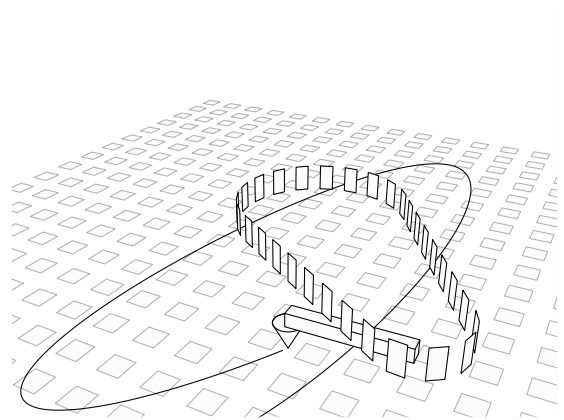

brownellips.0

true(1,2,3)

bstr.1

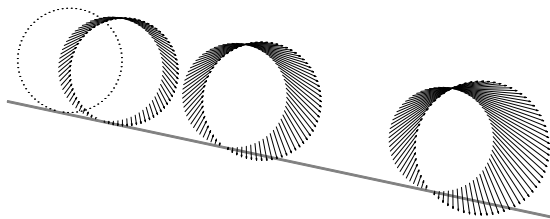

beautiful00.1

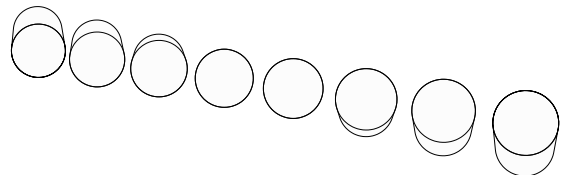

bughunt.1

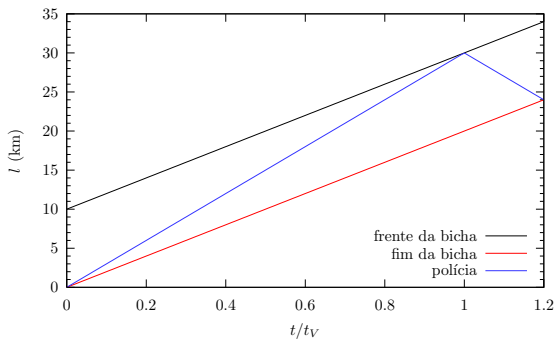

bichaepolicia.0

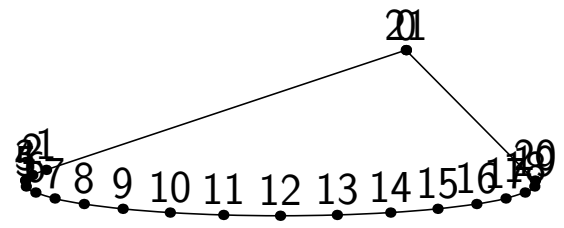

bughunt.2

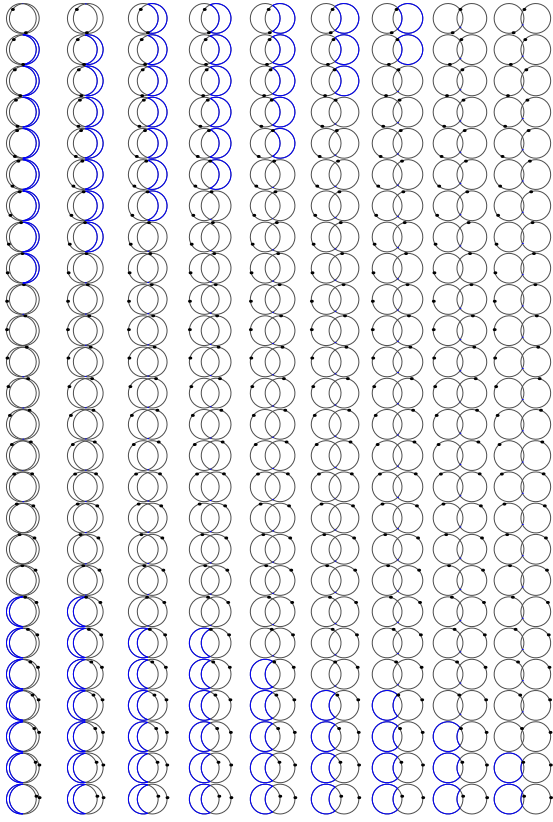

buildcyclebug.1

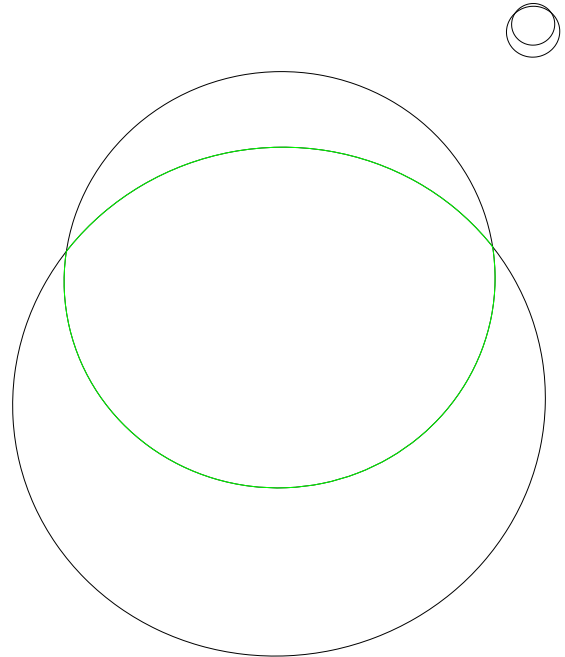

buildcyclebug.2

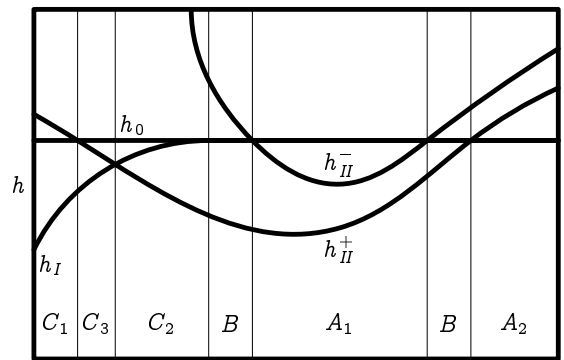

canschemes.1

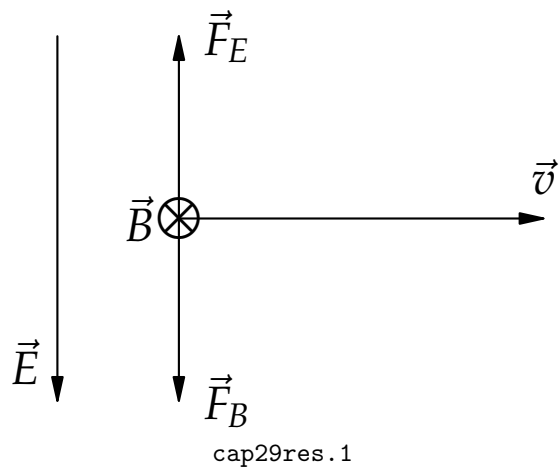
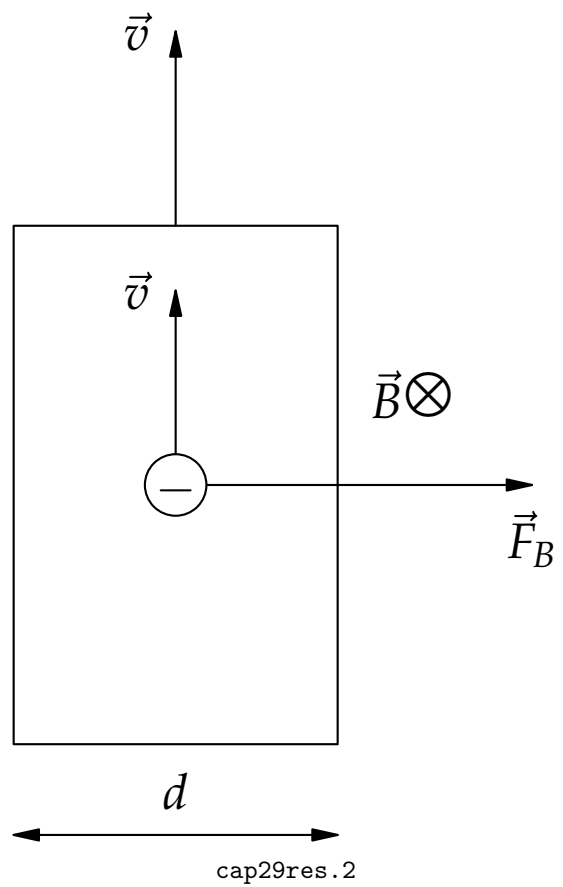
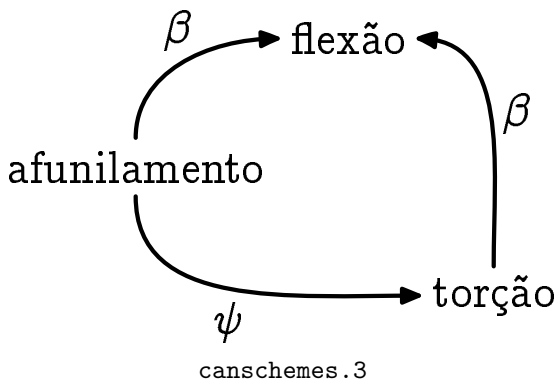
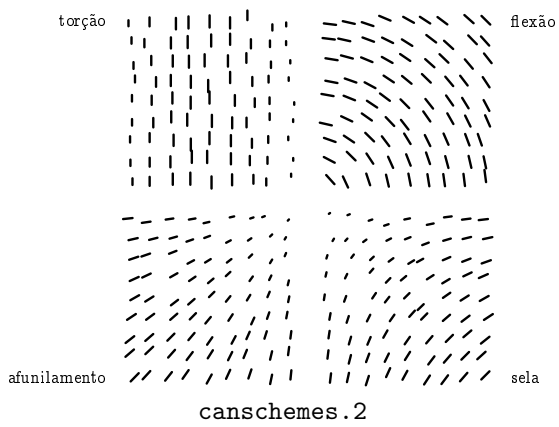

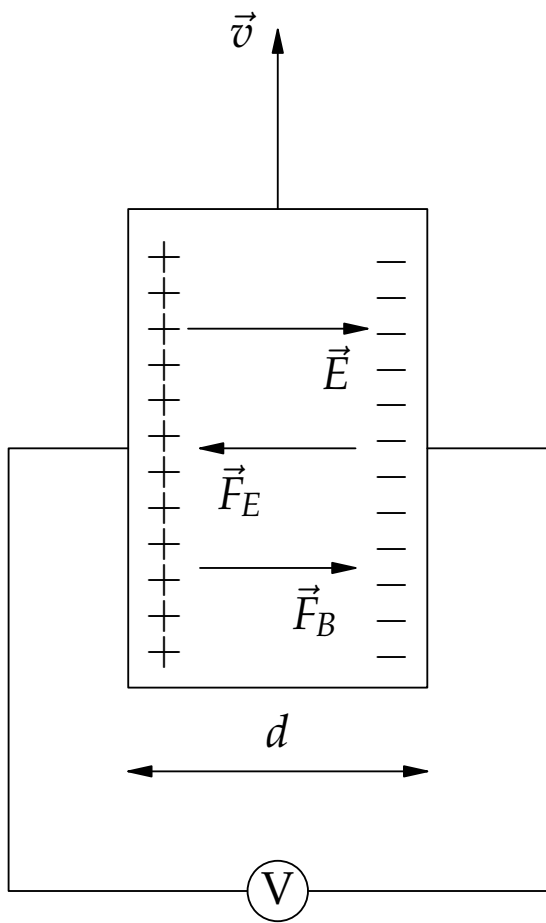

cap29res.3

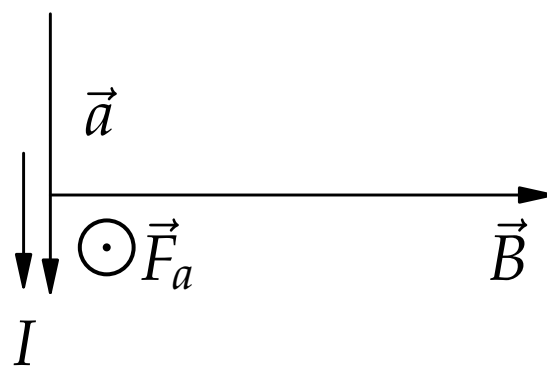

cap29res.5

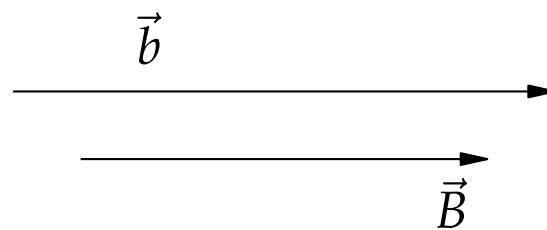

cap29res.6

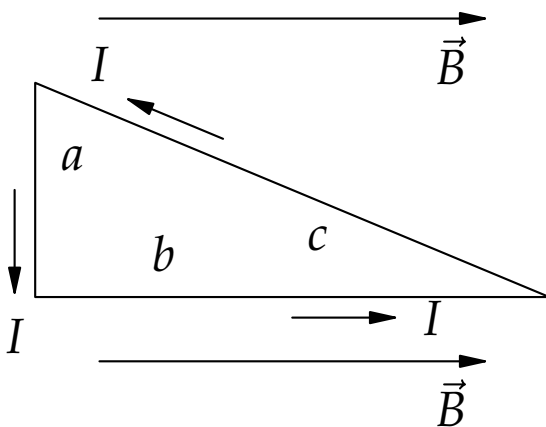

cap29res.4

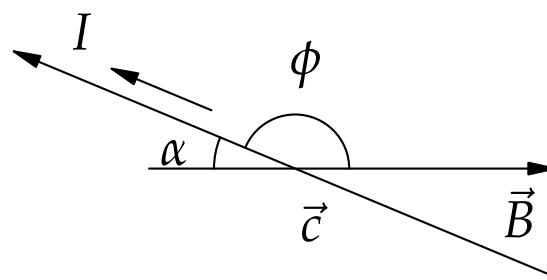

cap29res.7



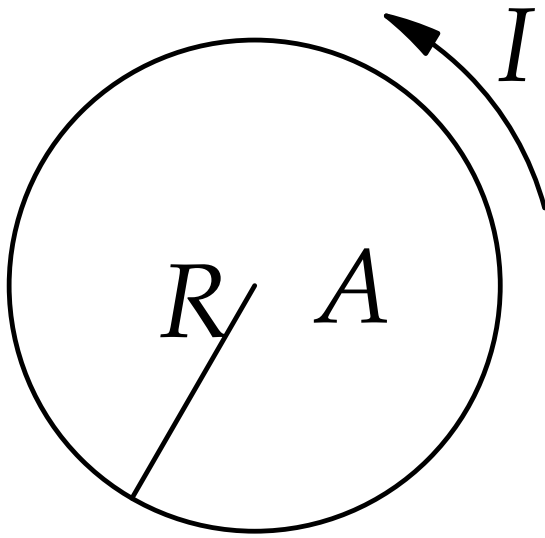

cap29res.8



caratk3edit.1

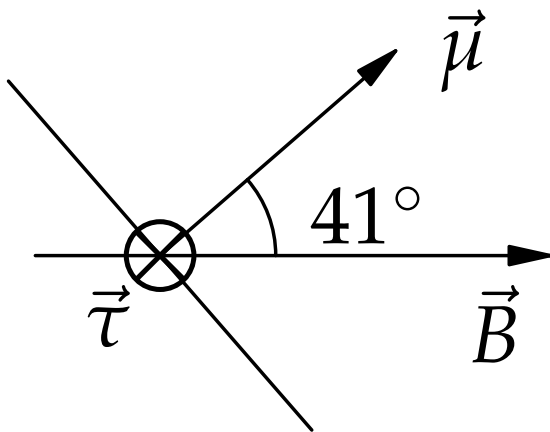

cap29res.9

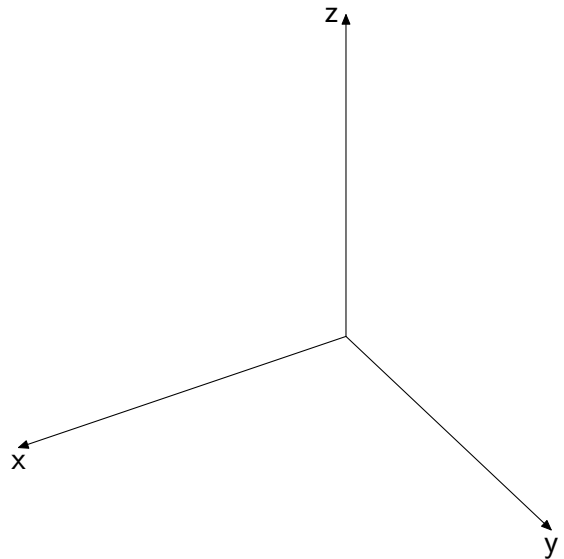

cartaxes.1

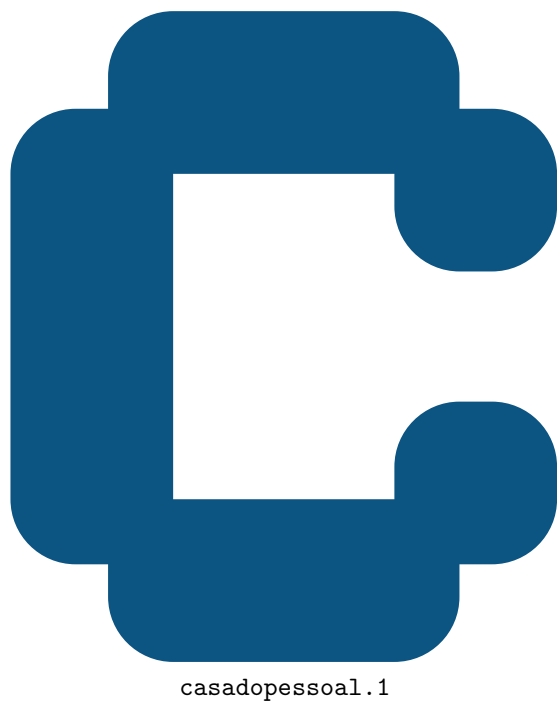
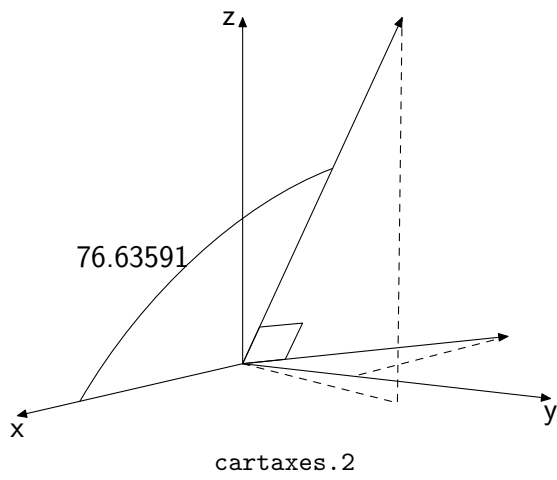



casadopessoal.4

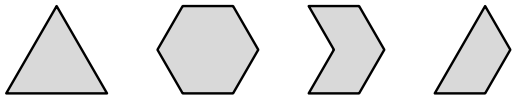

CAT.1

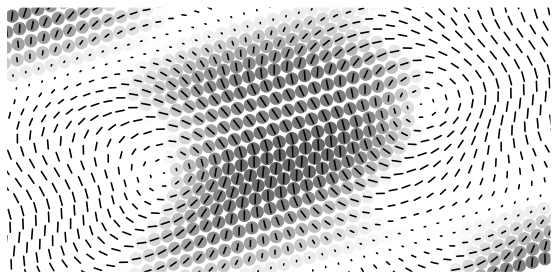

cellevolve.0

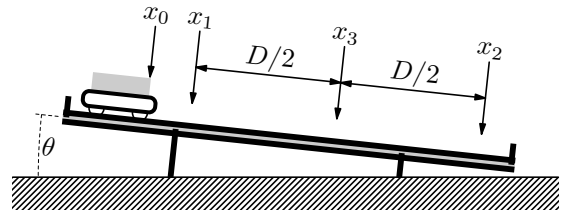

cinetwork.1

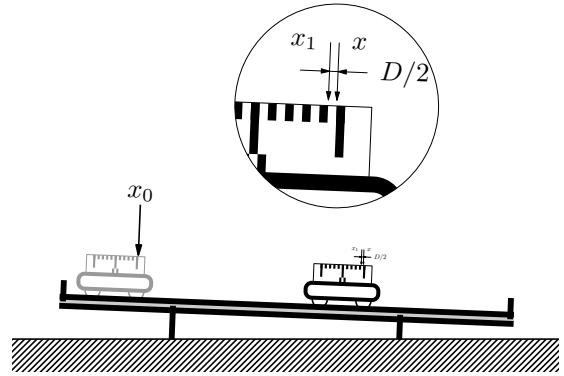

cinetwork.2

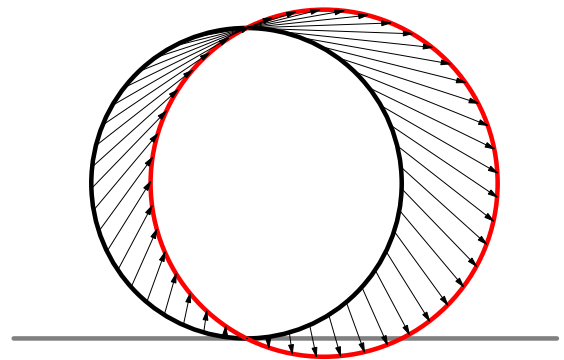

circlespeedprofile.1

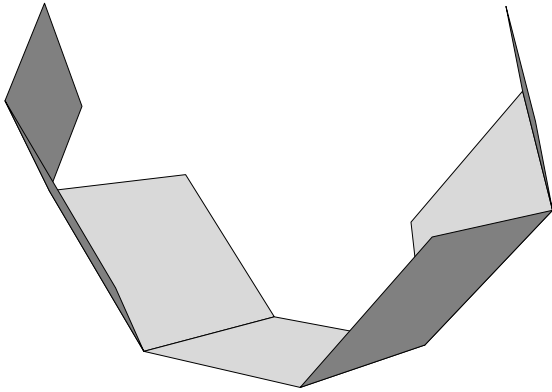

closingbox.1

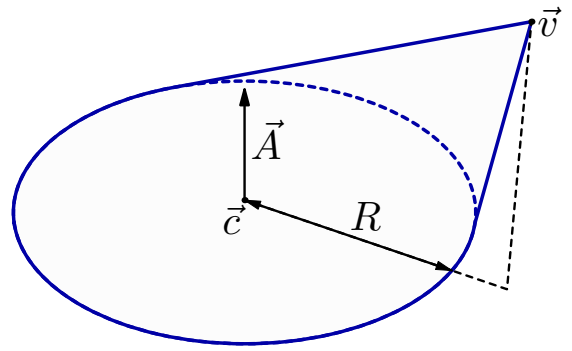

cone.1

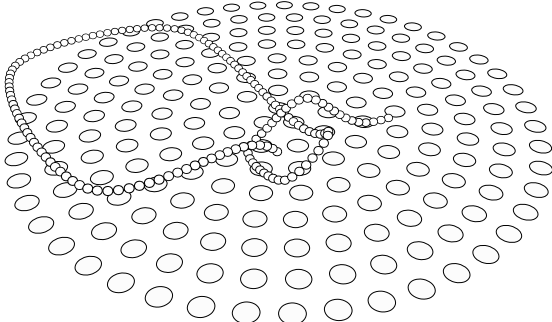

cmkropes.1

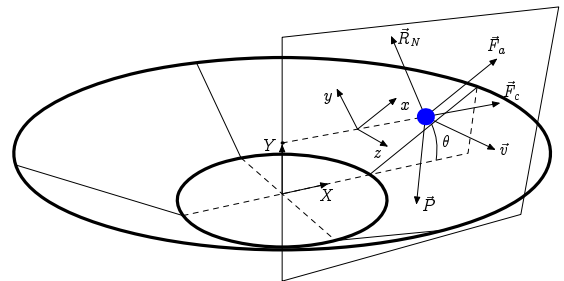

conicurv.1

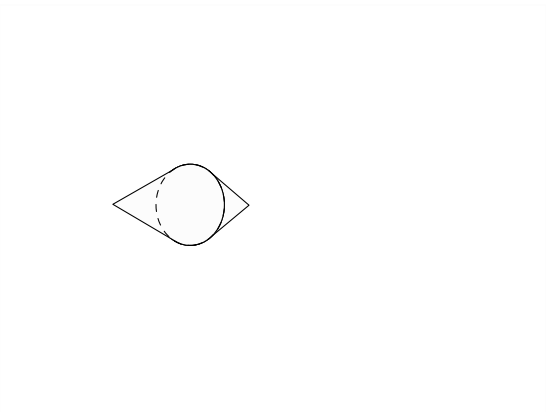

conegetready.1

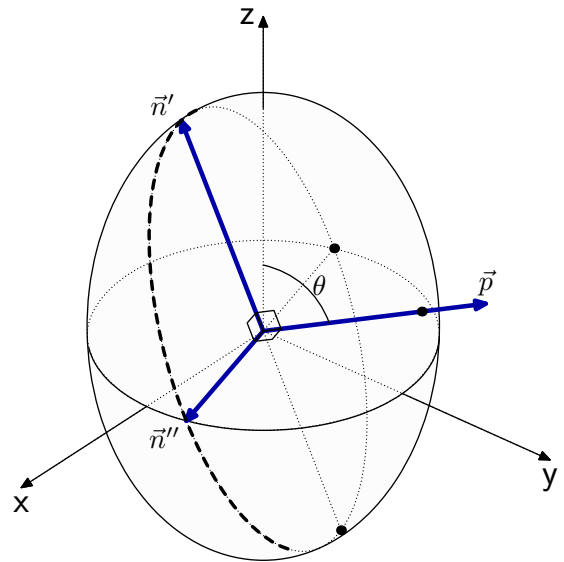

conoscopy.1

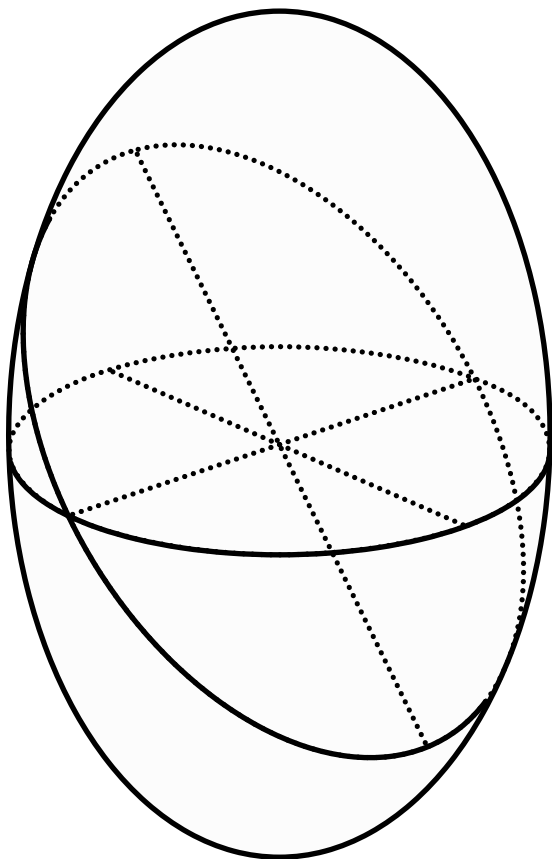

conoscopy .2

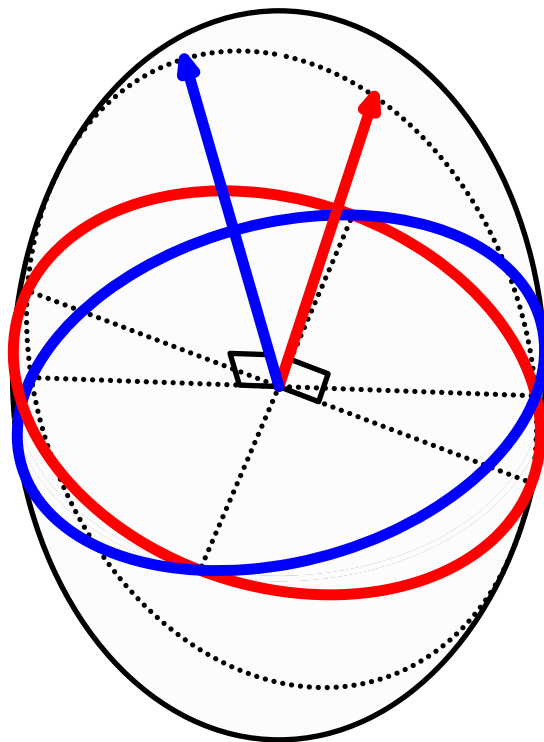

conoscopy .3

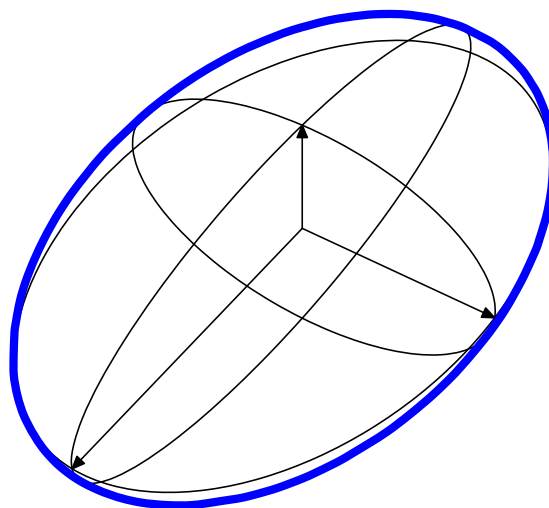

conoscopy .4

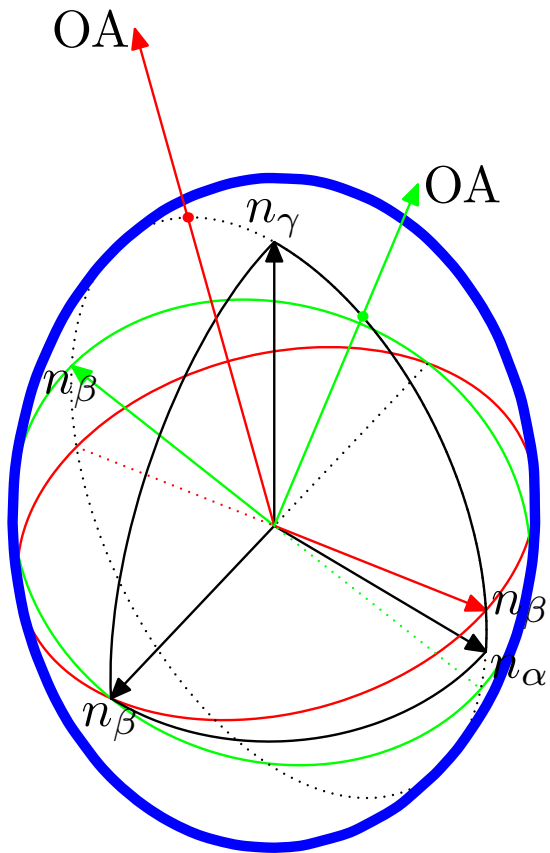

conoscopy.5

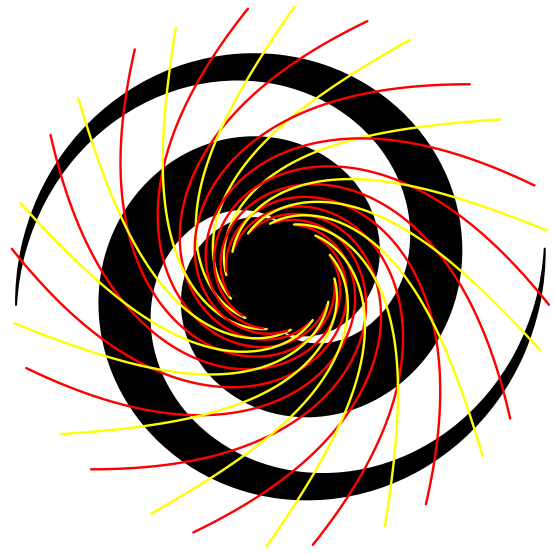

convergingspirals.2

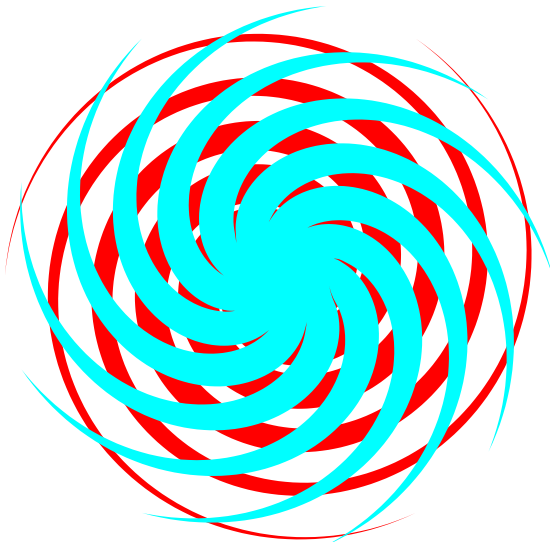

convergingspirals.1

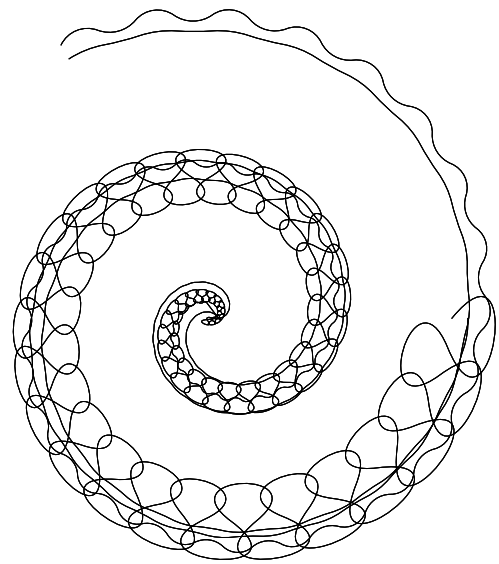

convergingspirals.3



convergingspirals.4

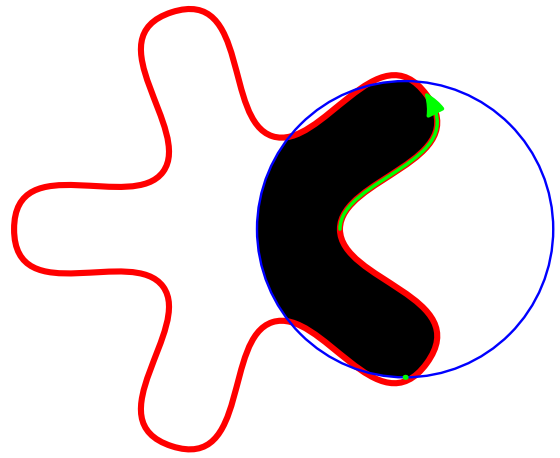

crossingline.1

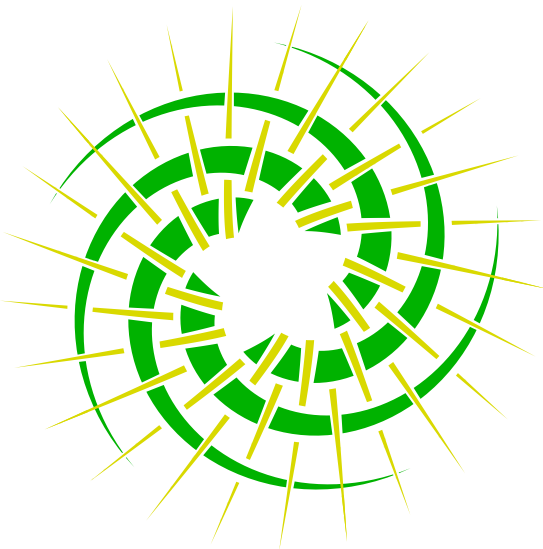

convergingspirals.5

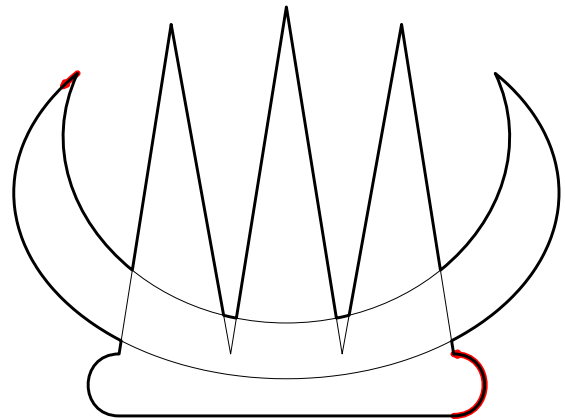

crossingline.2



crossingline.3

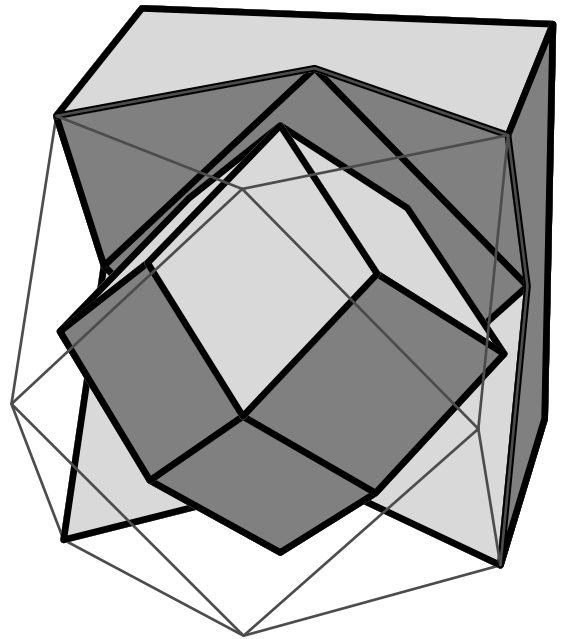

cubicfacecentered.1

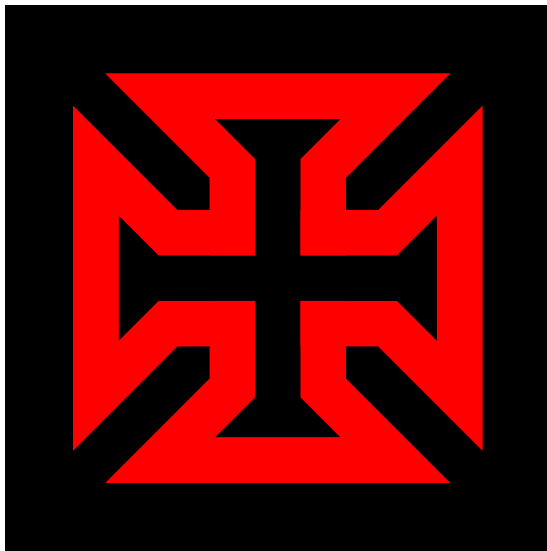

cruztuga.1

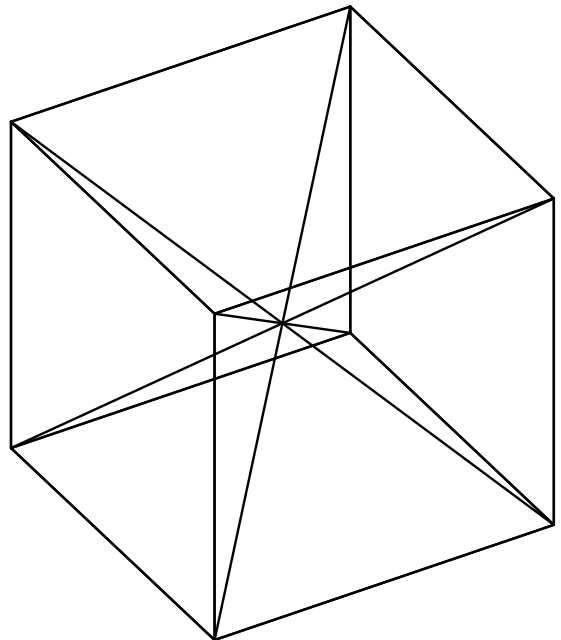

cubicfigures.1



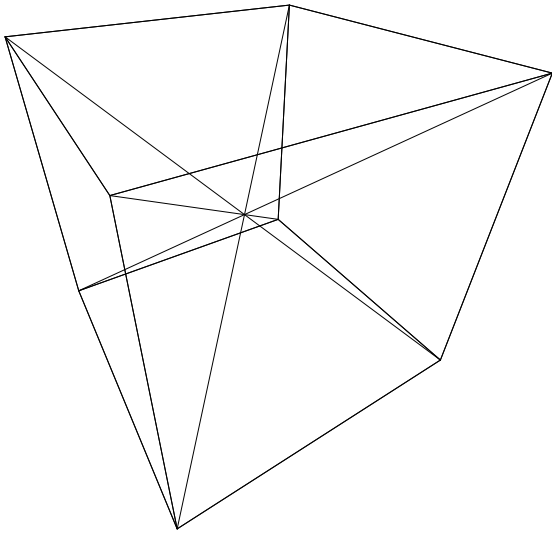

cubicfigures.2

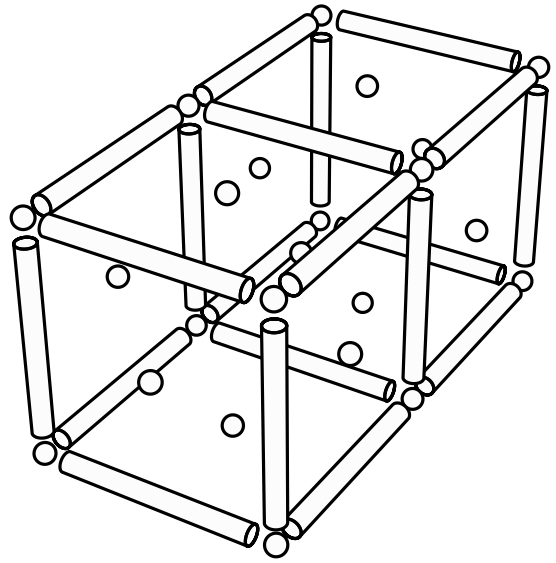

cubicstructurefcc.1

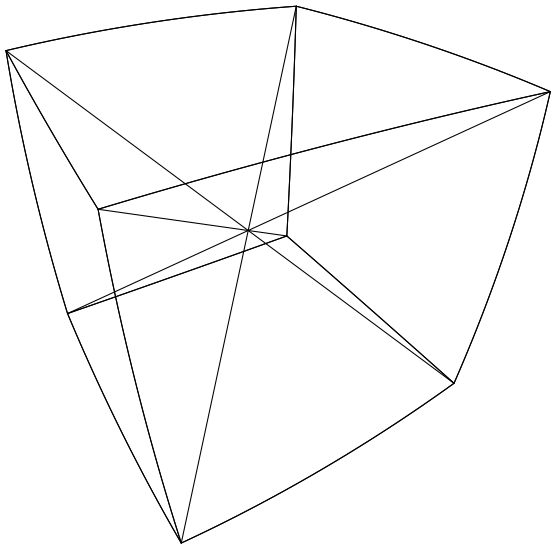

cubicfigures.3

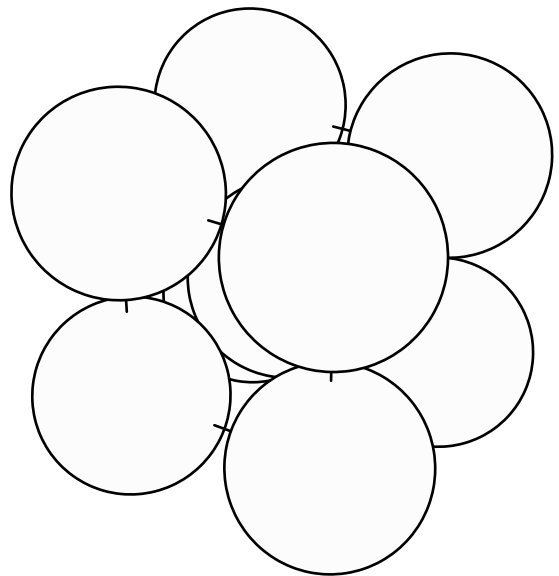

cubicstructures.1

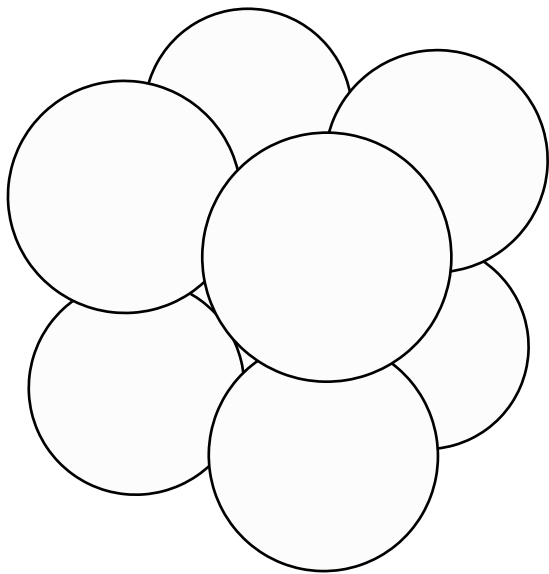

cubicstructures.2

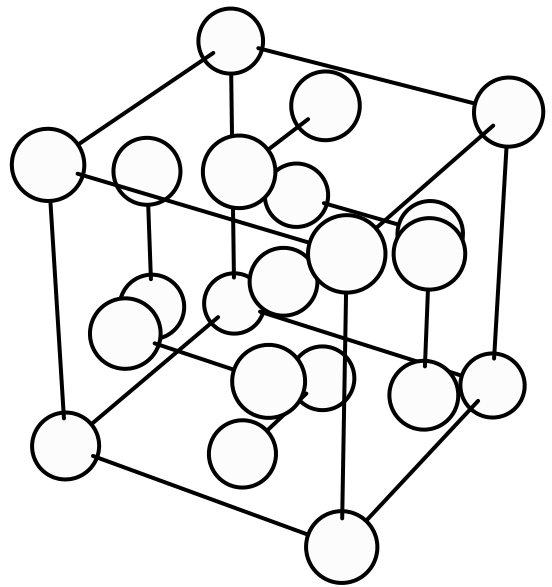

cubicstructures.4

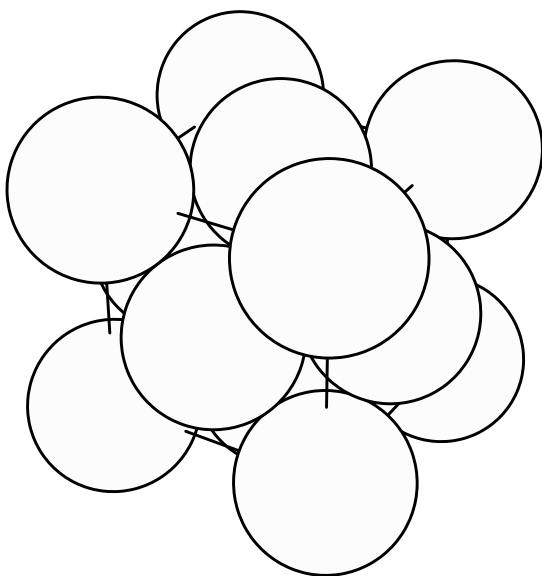

cubicstructures.3

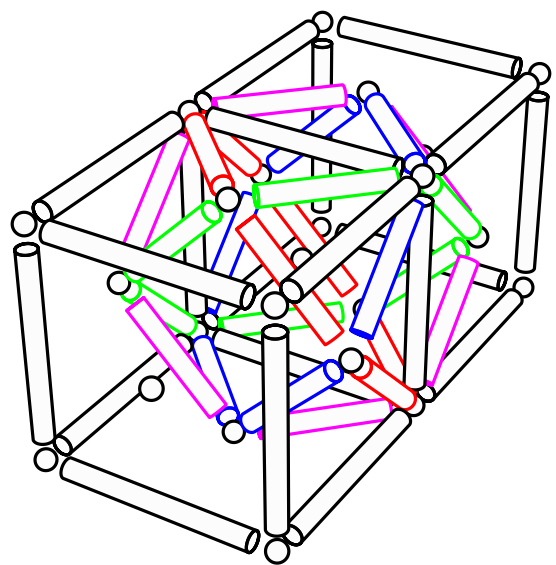

cubicstructures.5

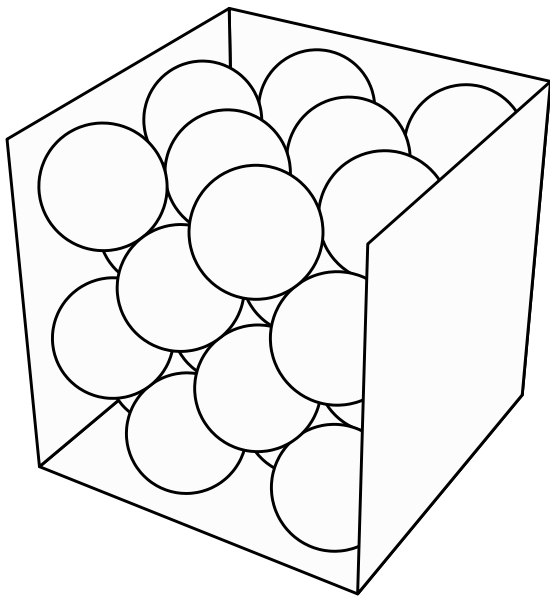

cubicstructures.6

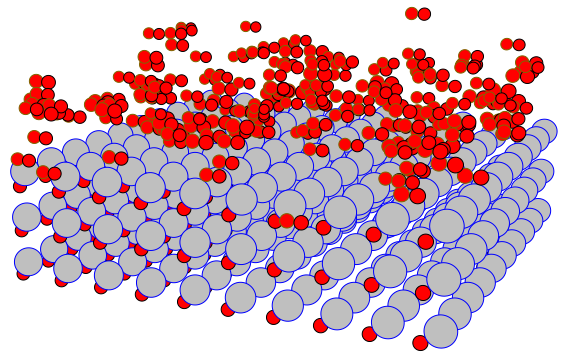

daliasensor.1

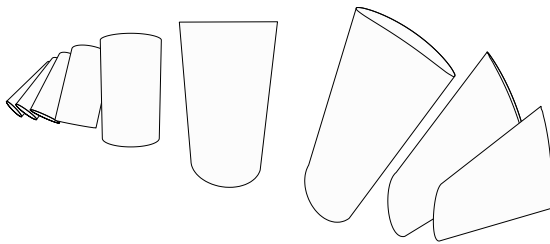

cylinple.1

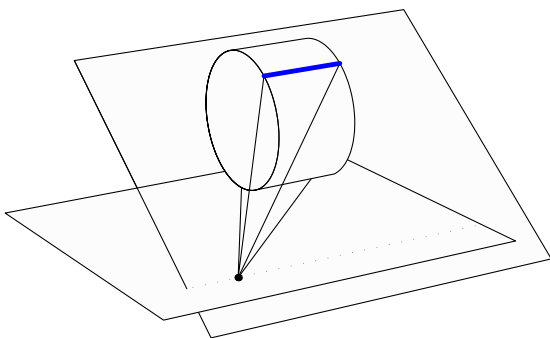

cylinderborders.1

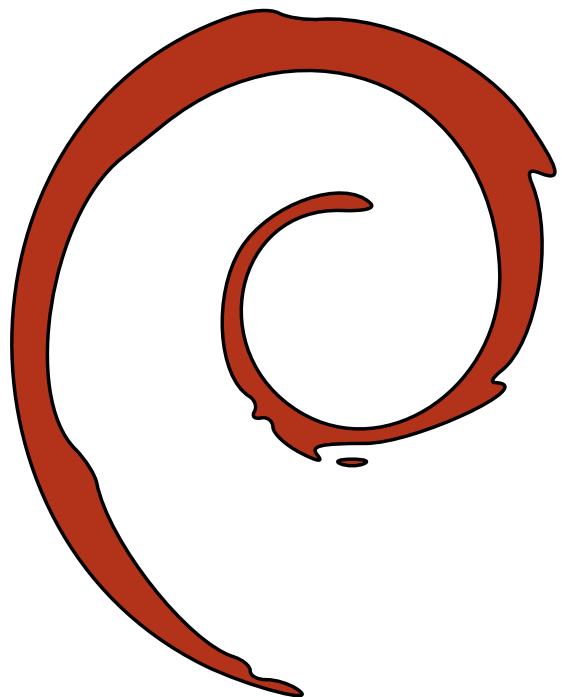

DebianSwirlsmallEdited.1

Pictures  
from  
Out There

decorstatement.0

Be  
Aware  
of  
Technical  
Arrogance.

defaultcmr.0

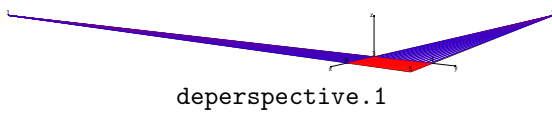

deperspective.1

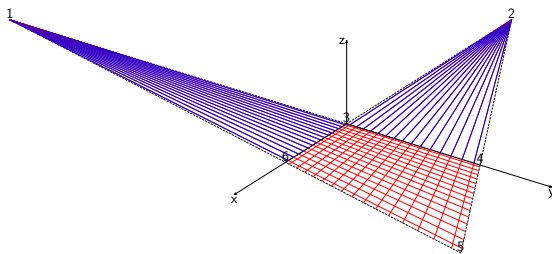

deperspective.2

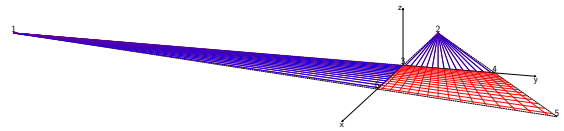

deperspective.3

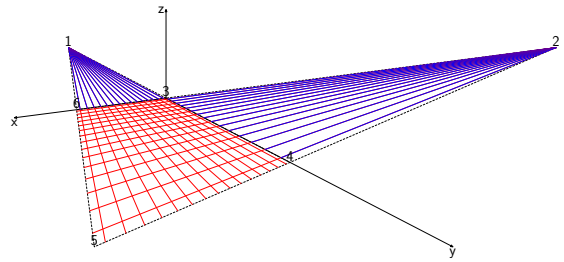

deperspective.4

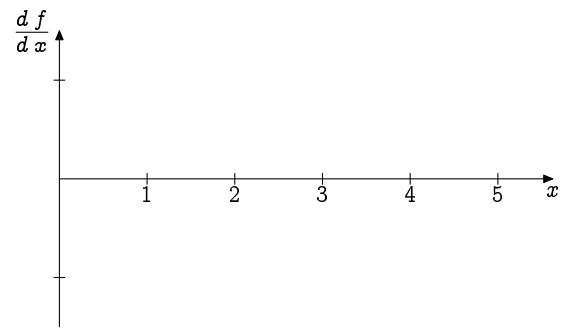
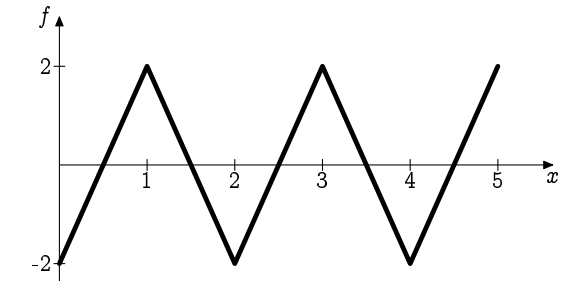

derivondatriang.1

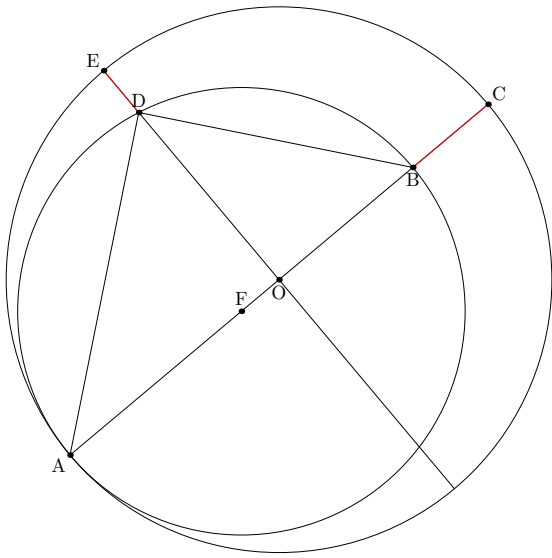

diameters.1

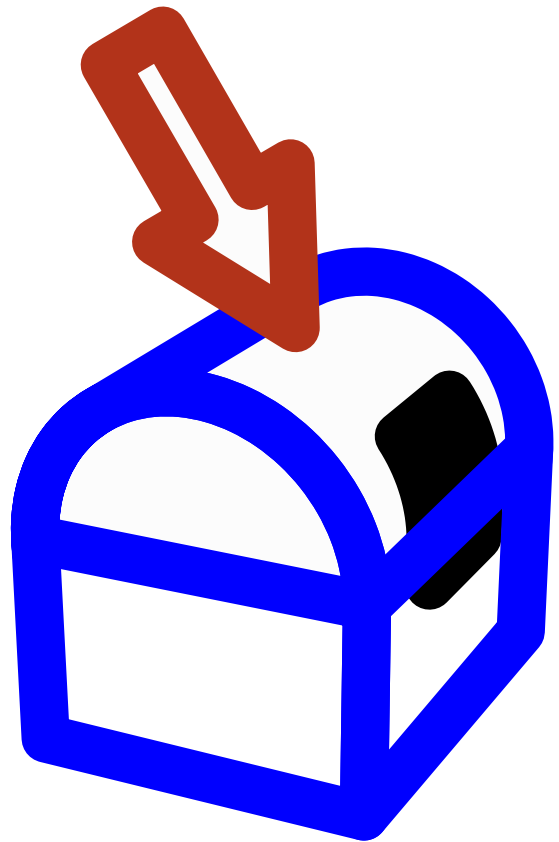

downloadicon.1

QWERTYUIOPasdfghjklZXCVBNM

What gives?

0.123,456,789

directfonts.0

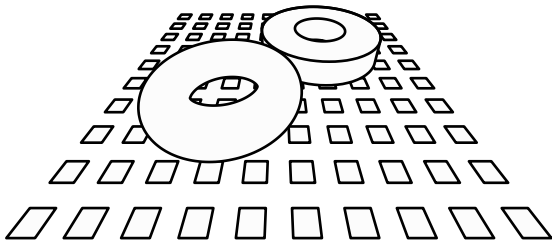

doitnow.1

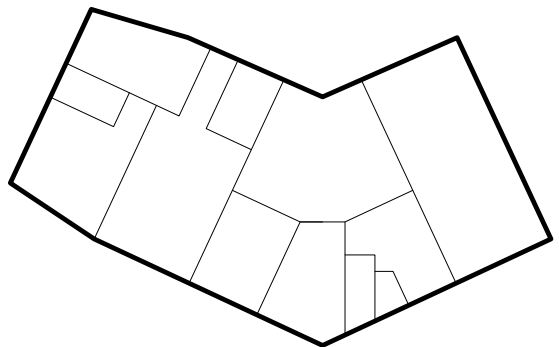

dreamhouse.1

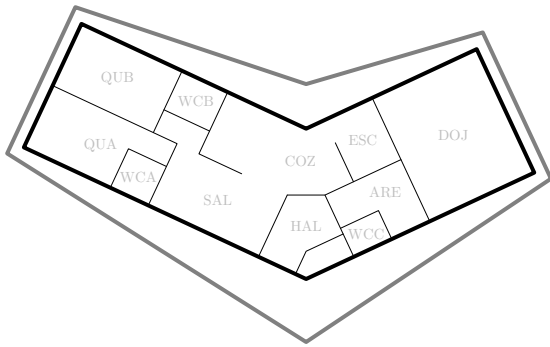

dreamhouse.2

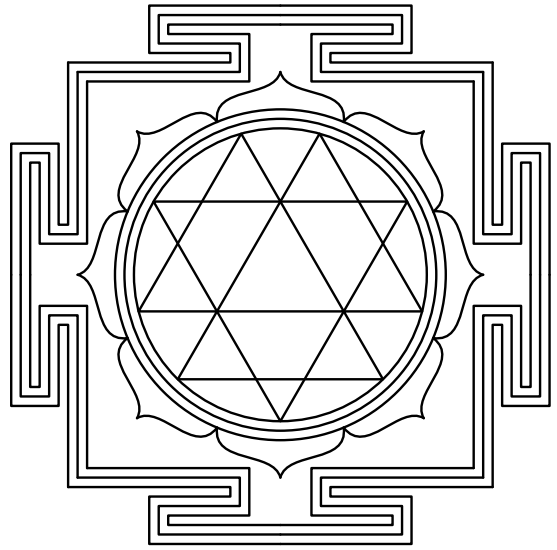

durgayantra.2

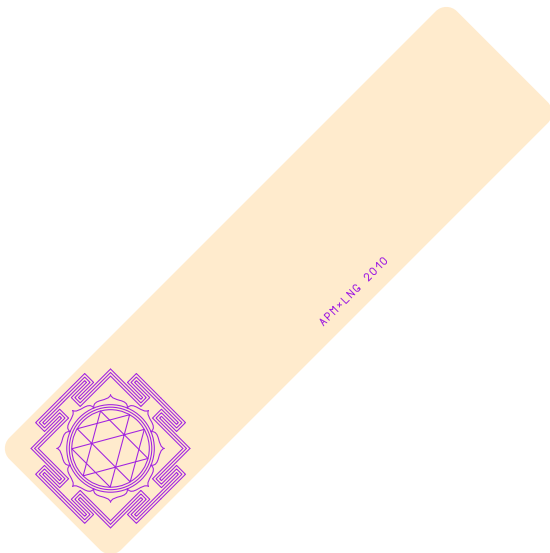

durgayantra.1

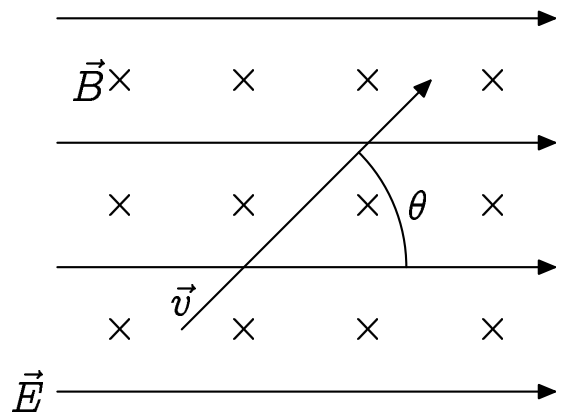

EBcrossed.1

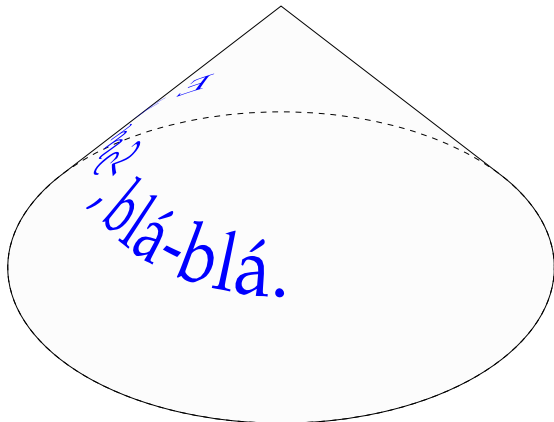

eemcsblabla.1

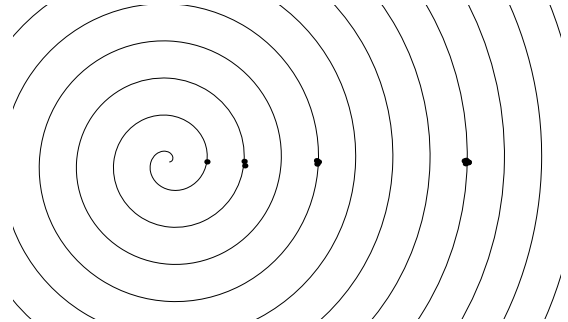

electrospiral.1

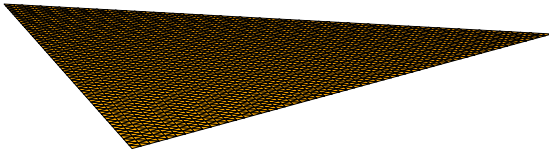

electricpotential.0

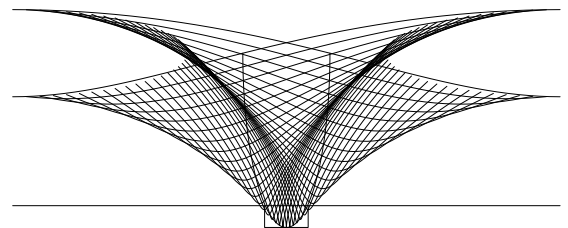

ellipticextrusionpress.1

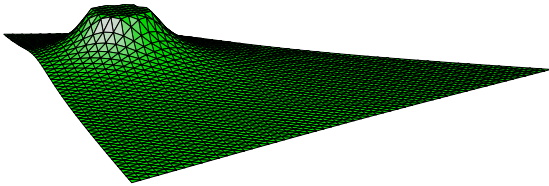

electricpotential.1

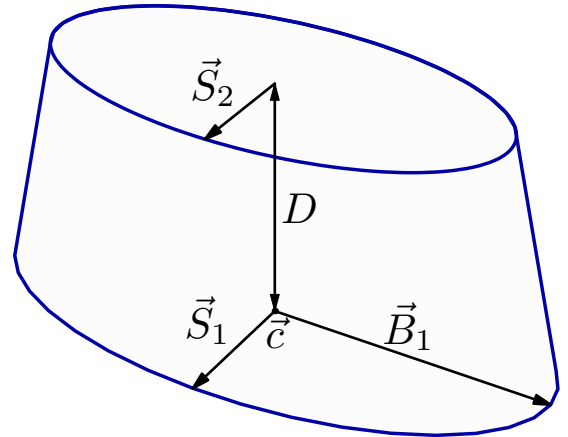

ellipticprism.1

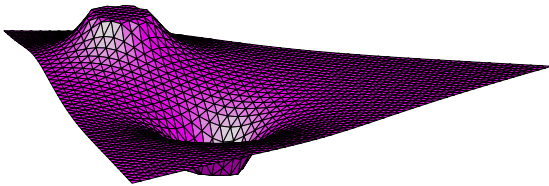

electricpotential.2

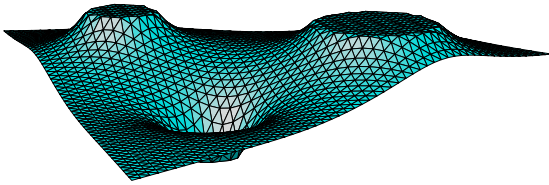

electricpotential.3

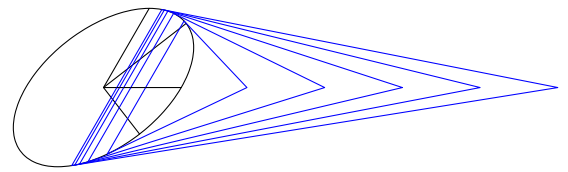

ellipticproperties.1

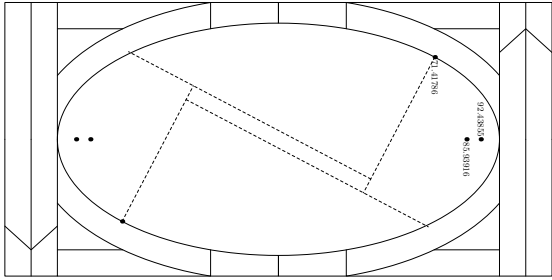

elliptictable.1



embroncordada.1

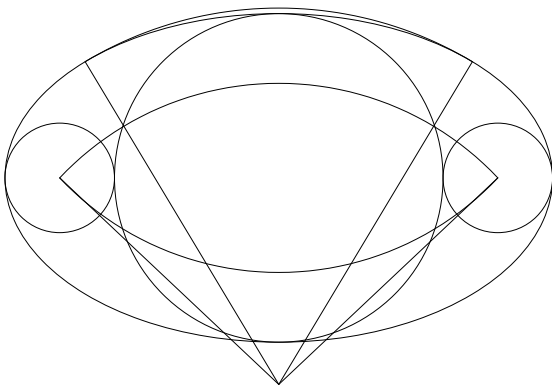

ellipticthing.1



emptylines.1



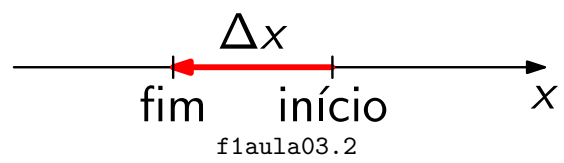
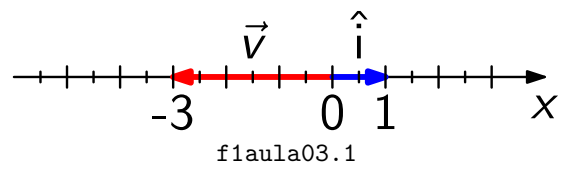
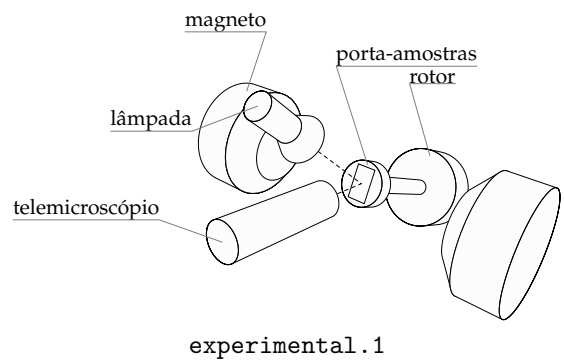
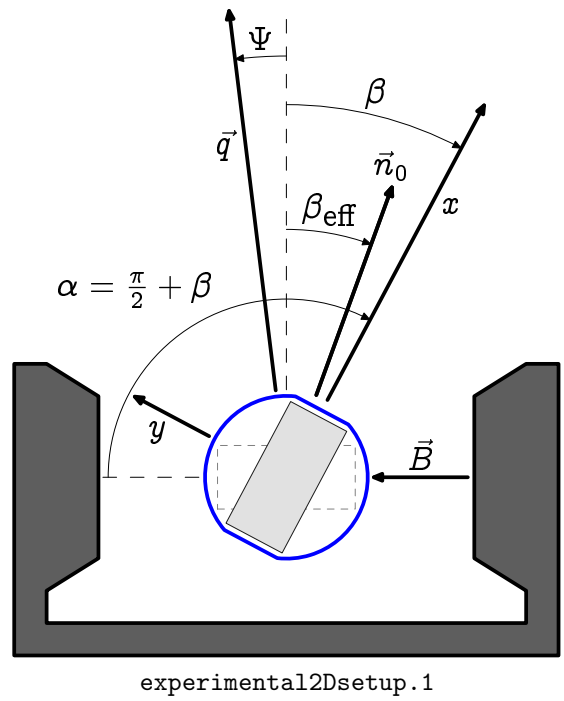
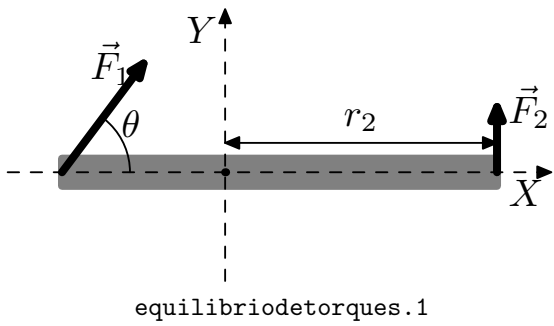
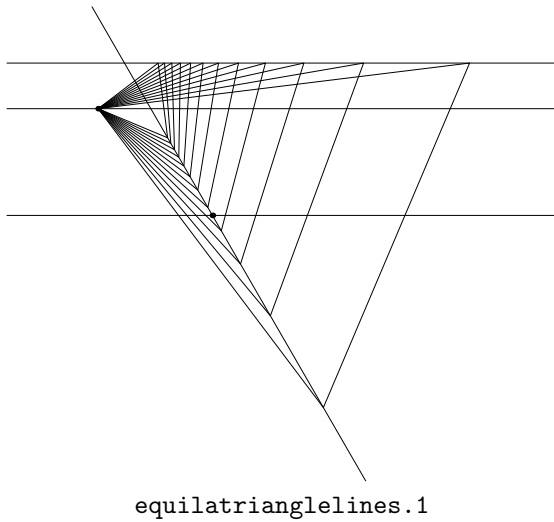

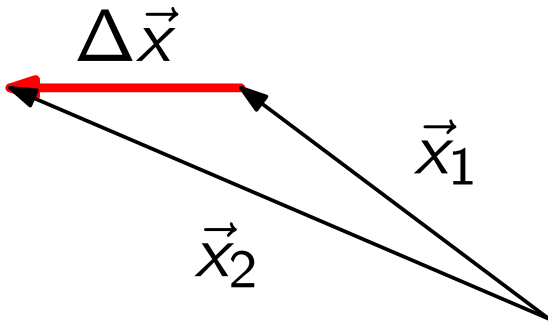

f1aula03.3

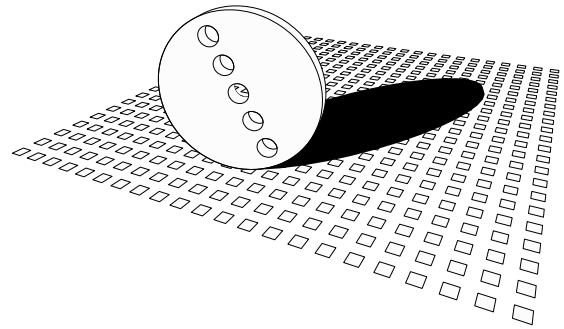

fakehole.1

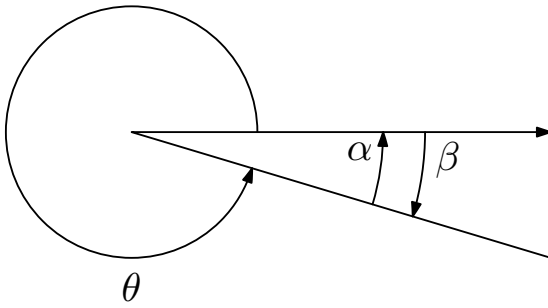

f1aula03.4

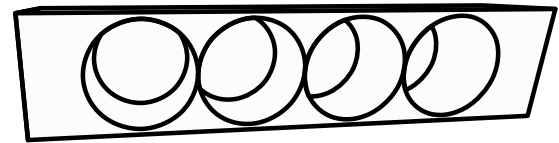

fakehole.2

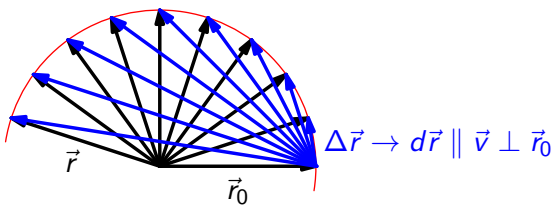

f1aula05.1

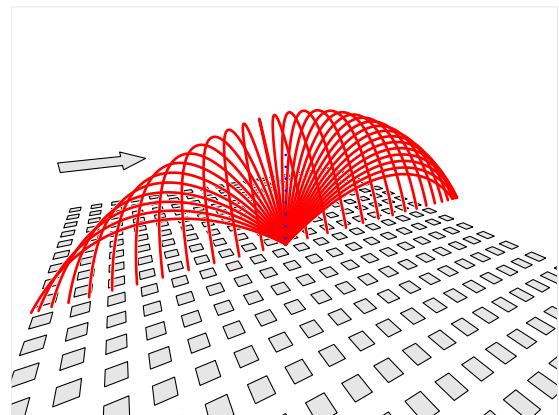

fallinthewind.1

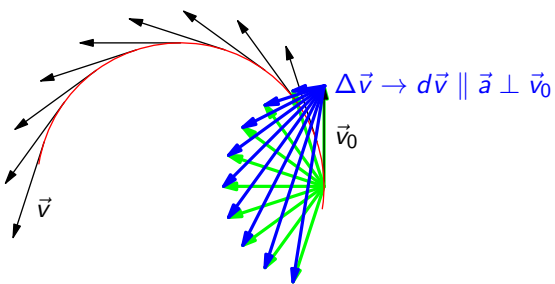

f1aula05.2



featpostlogo.1

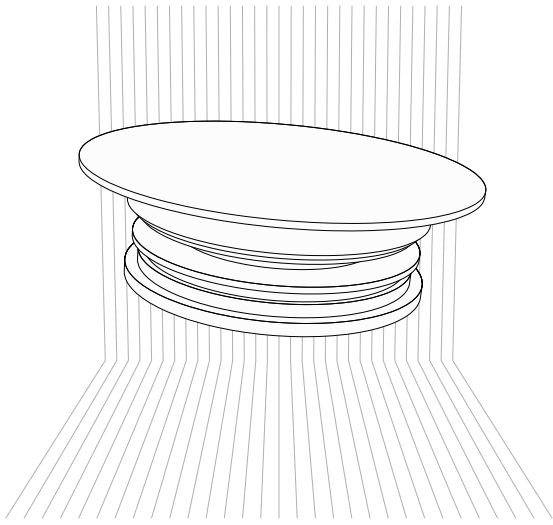

ffcbob.1

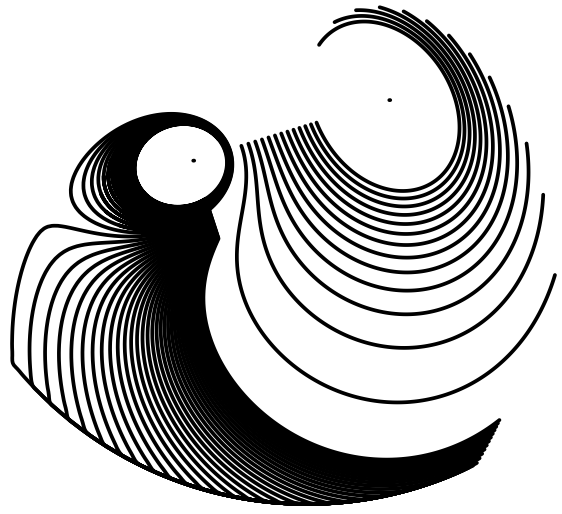

fieldlinesnorma.2

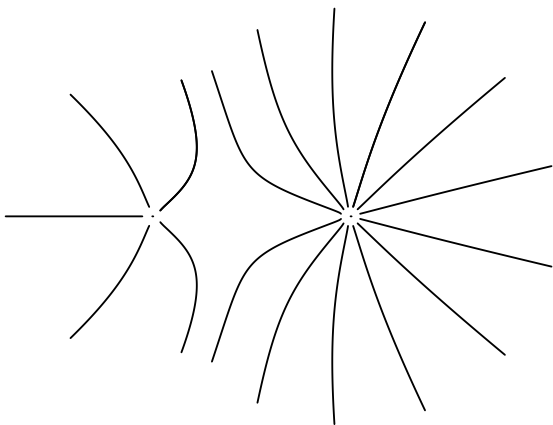

fieldlines.1

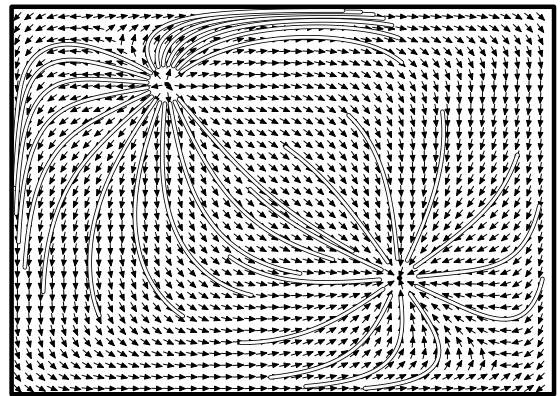

fieldlinesnormapaper.1

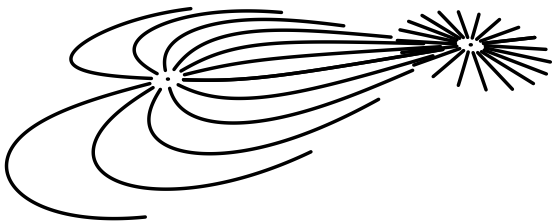

fieldlinesnorma.1

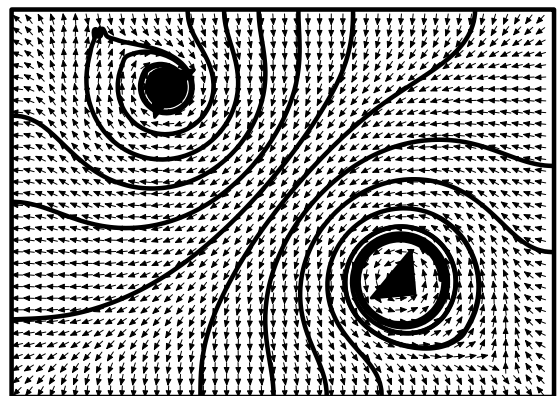

fieldlinesnormapaper.2

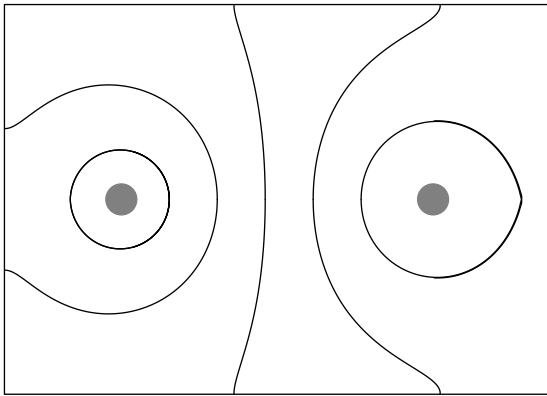

fieldlinesnormapaperwork.1

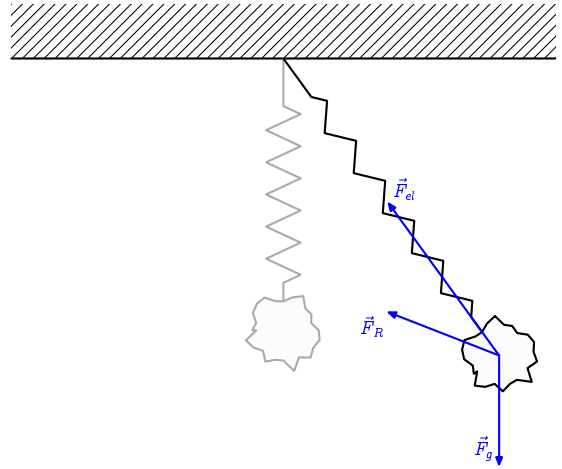

fis1prex.3

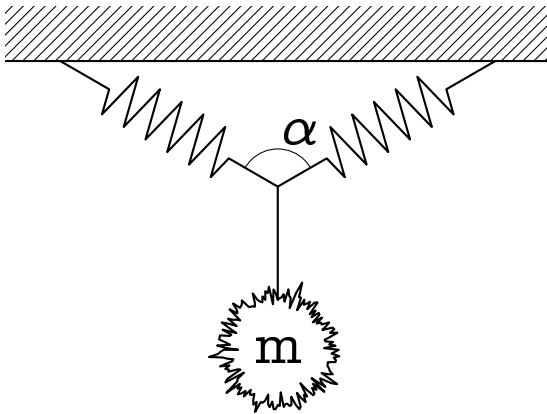

fis1prex.1

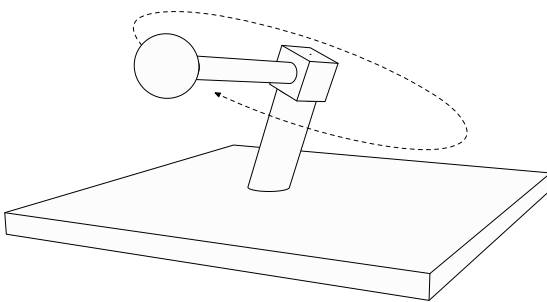

fis1prex.2

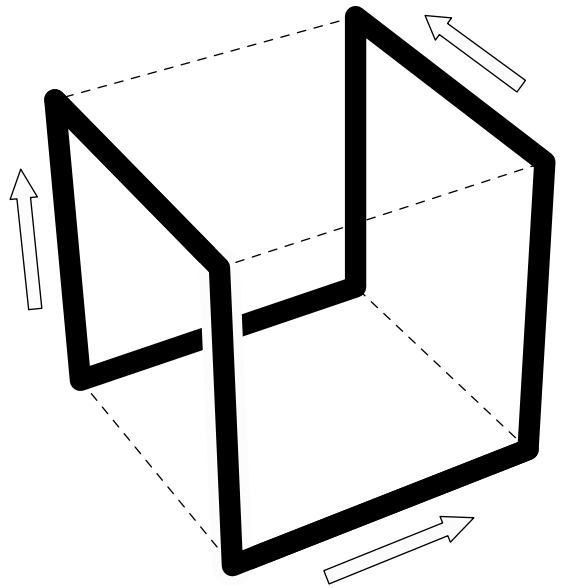

fis3prex7.1



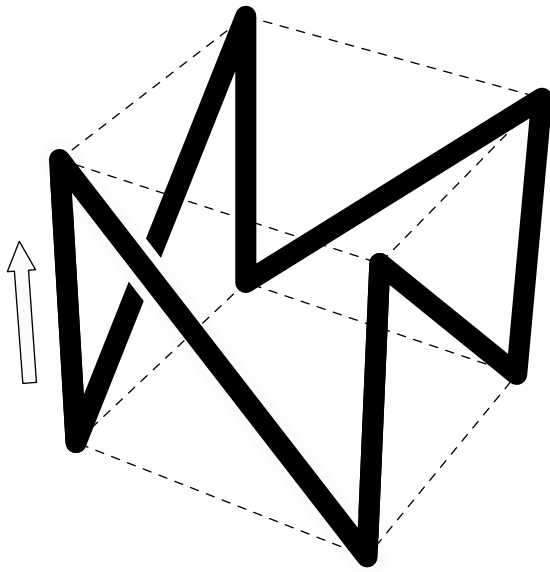

fis3prex7.6

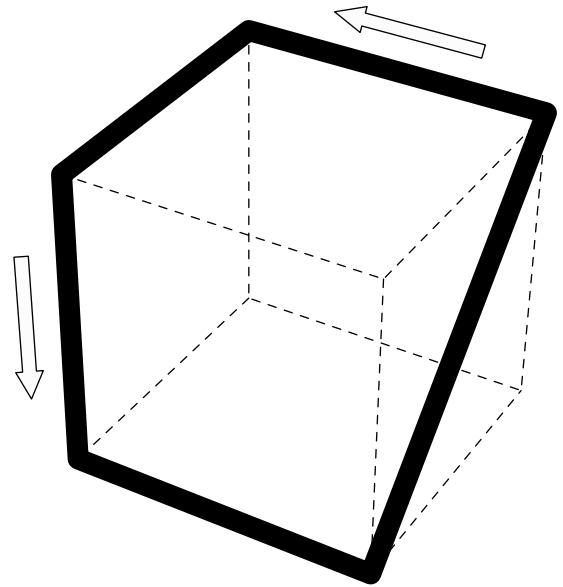

fis3prex7.8

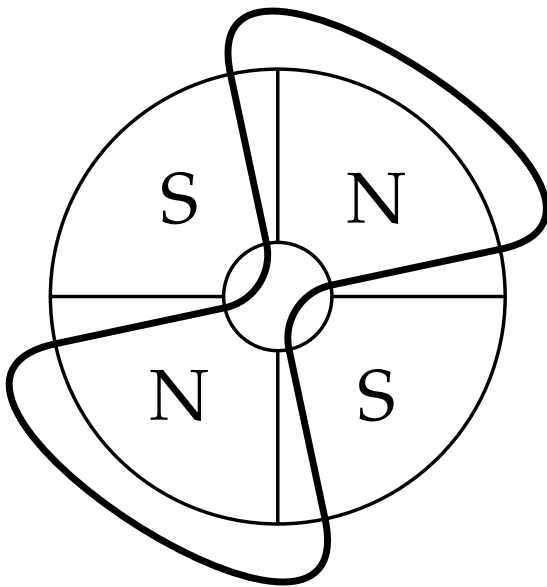

fis3prex7.7

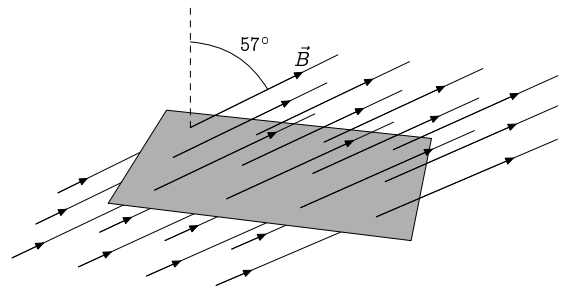

fis3prex.1

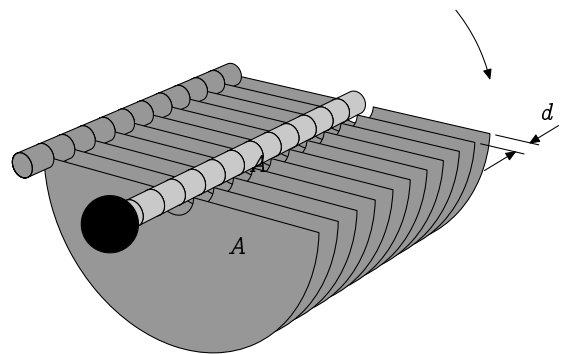

fis3prex.2

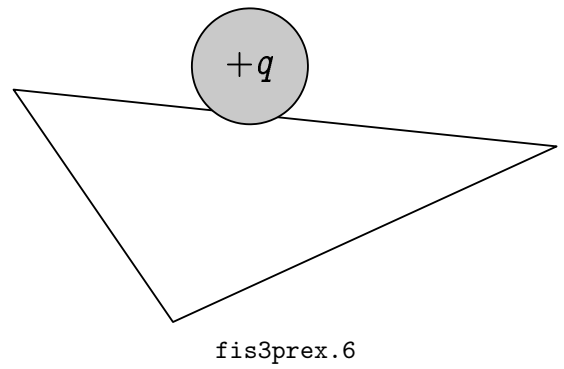
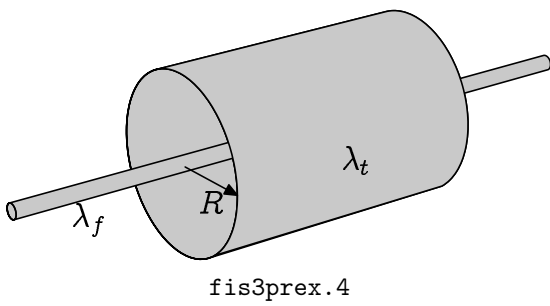
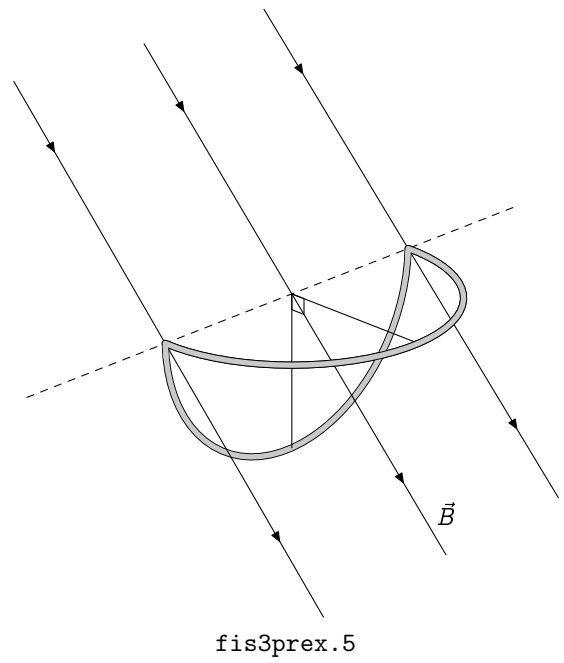
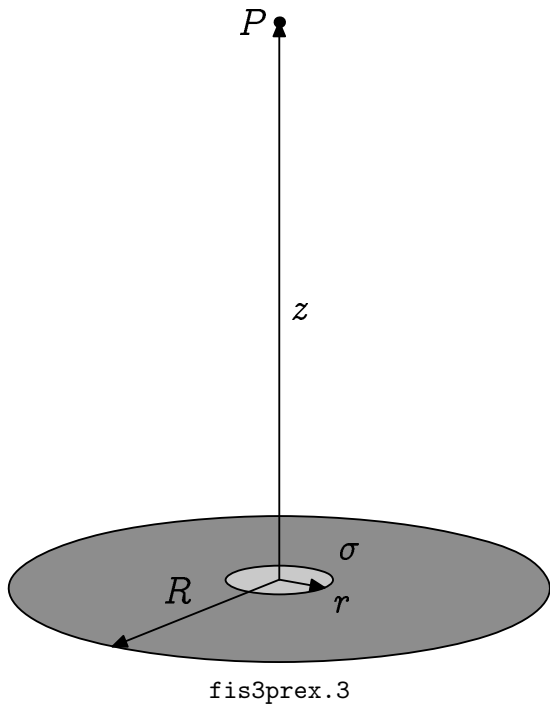

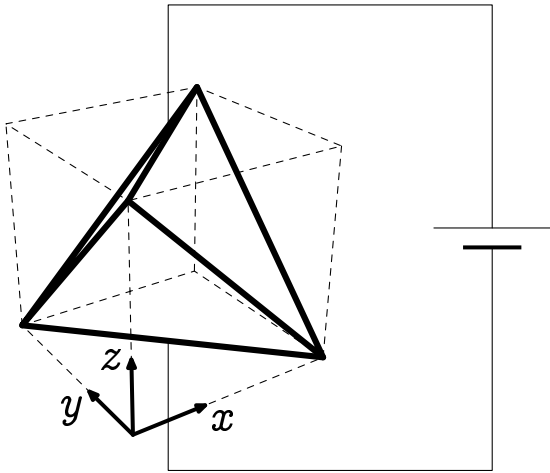

fis3prex.7

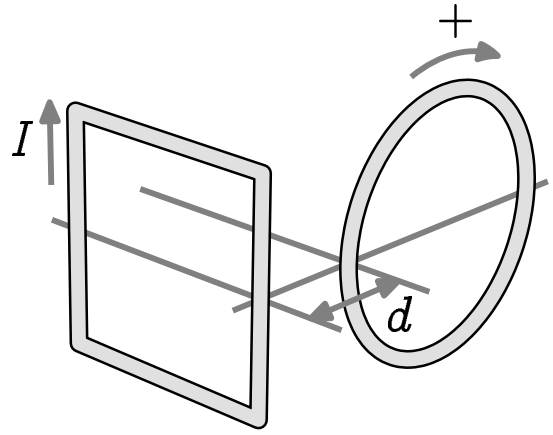

fis3prex.9

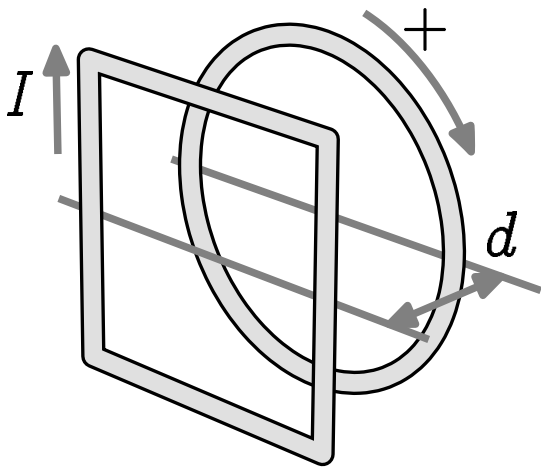

fis3prex.8

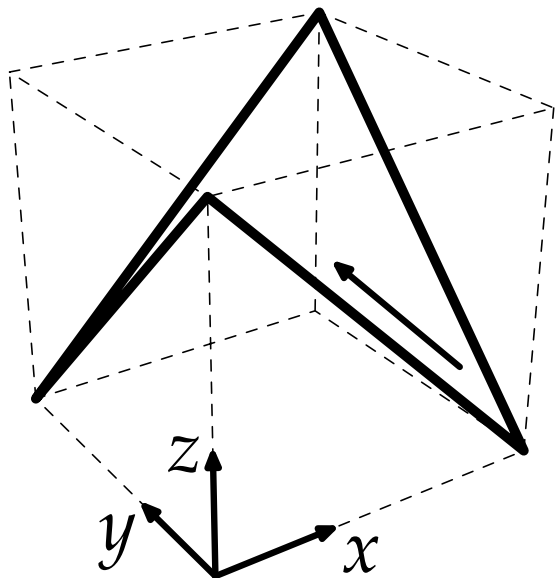

fis3prey.1



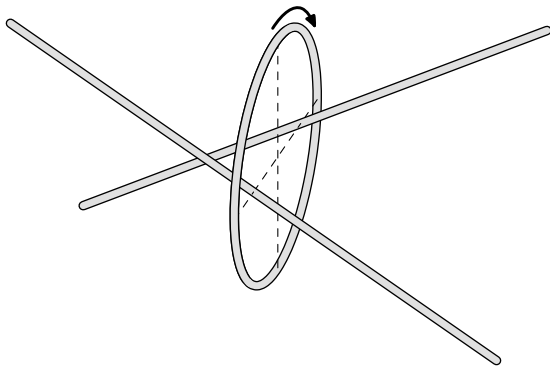

fis3prey.2

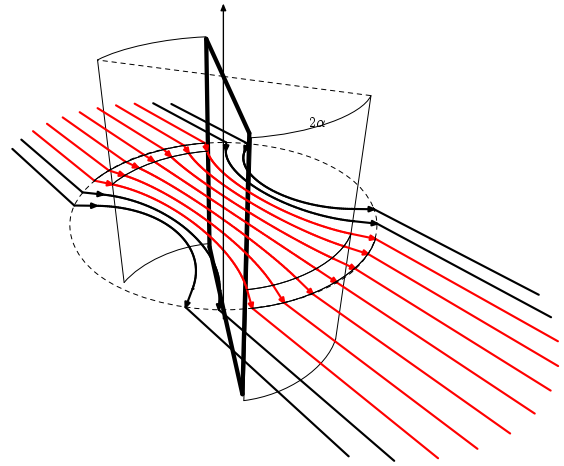

galvanometro-inducao.1

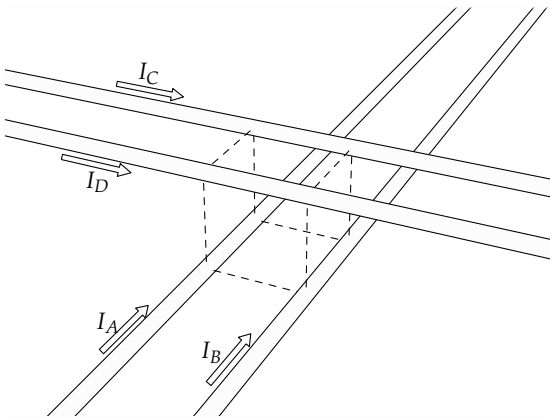

fis3prey.3

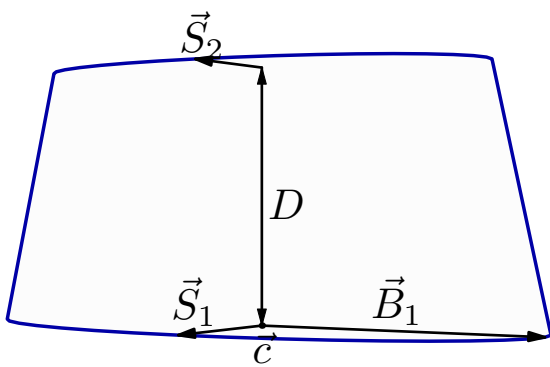

frustum.1

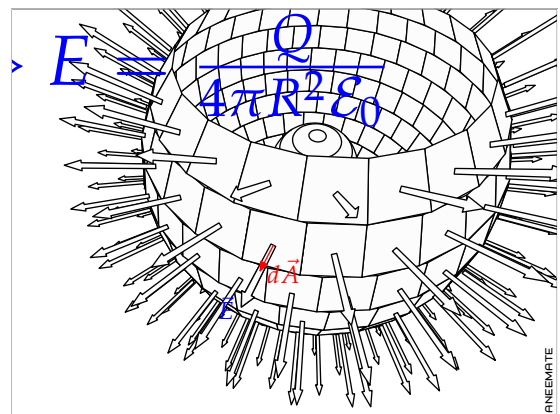

gausslawframe.1

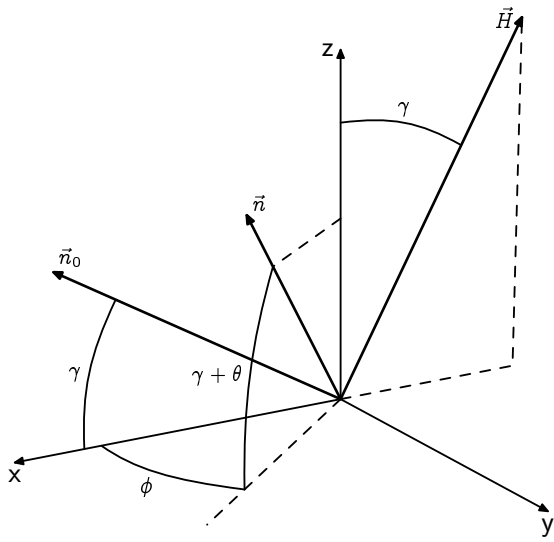

geombasic.1

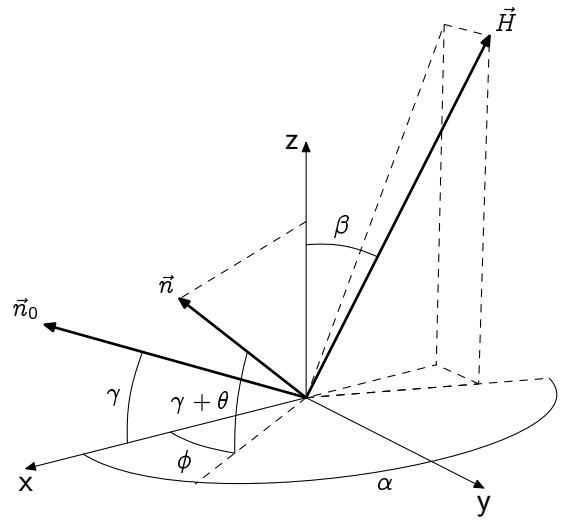

geomfigurei.1

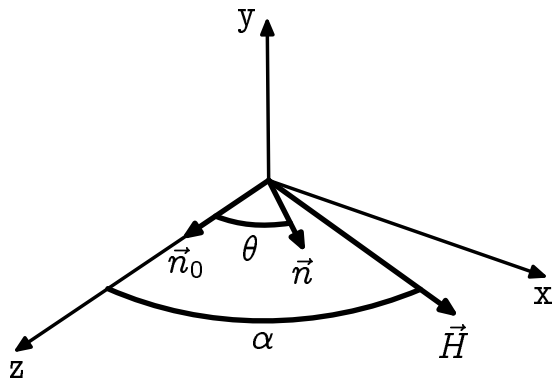

geomcasq.1

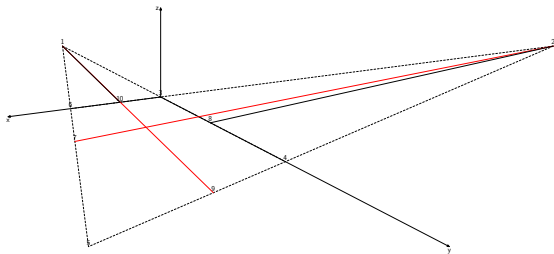

geometricaverage.1

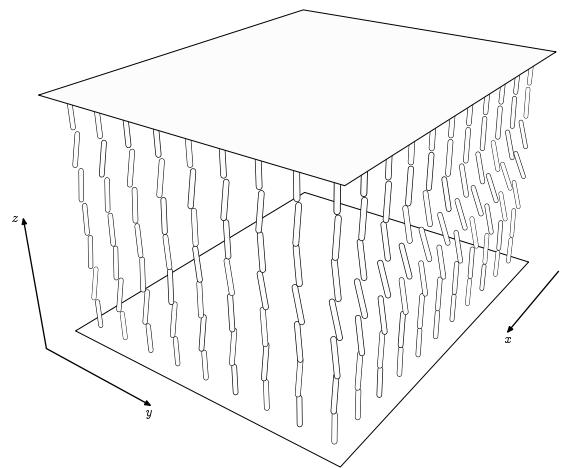

geomfreder.1

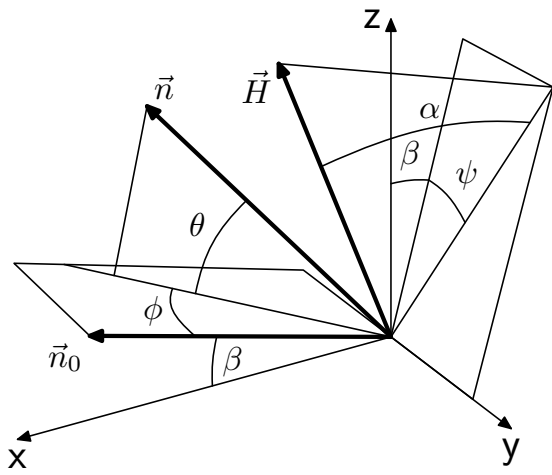

geommine.1

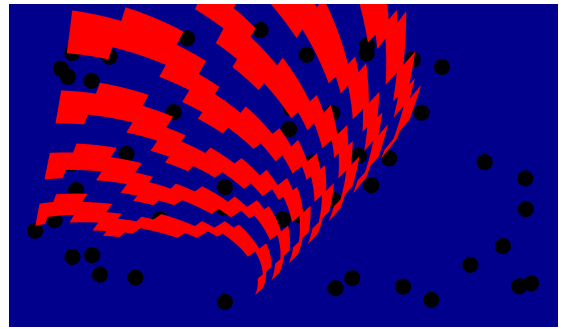

gnupost3Dlogo.1



gnupost.1

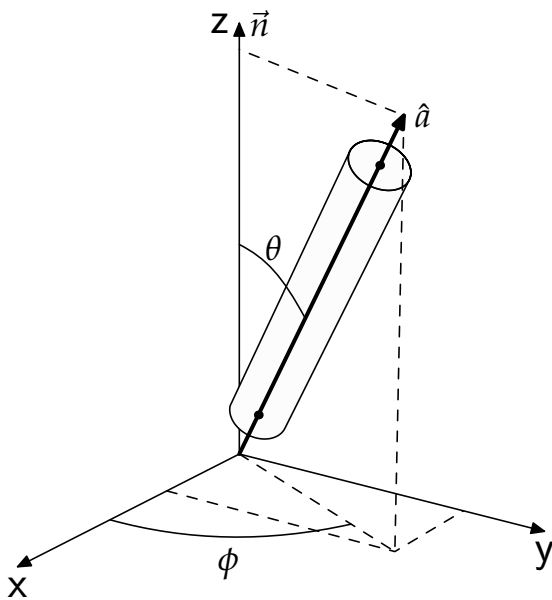

geomsrinath.1

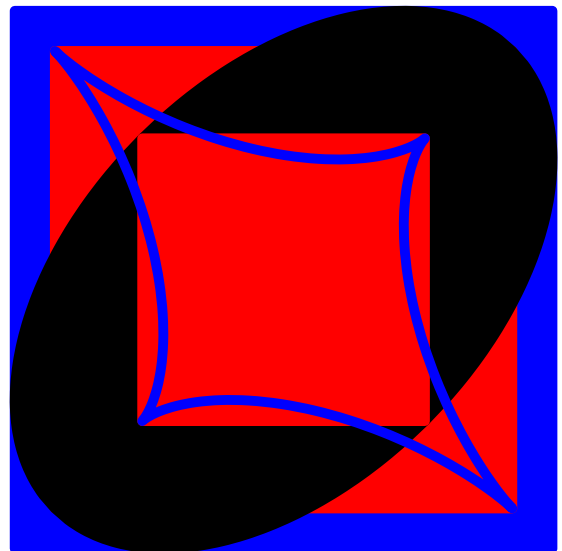

goldenellipse.1

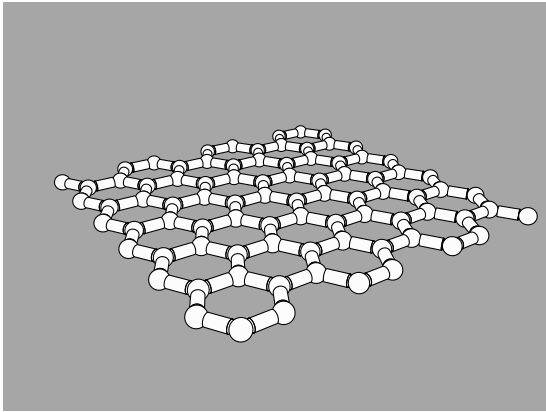

graphene.1

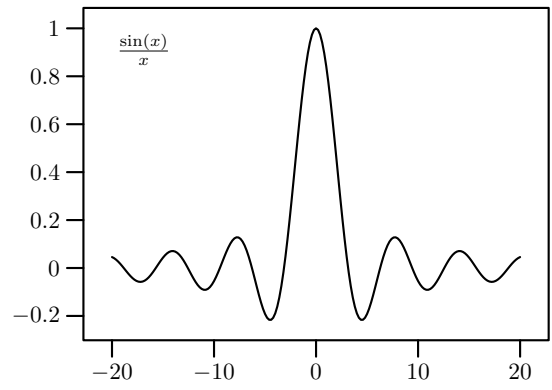

graphs.2

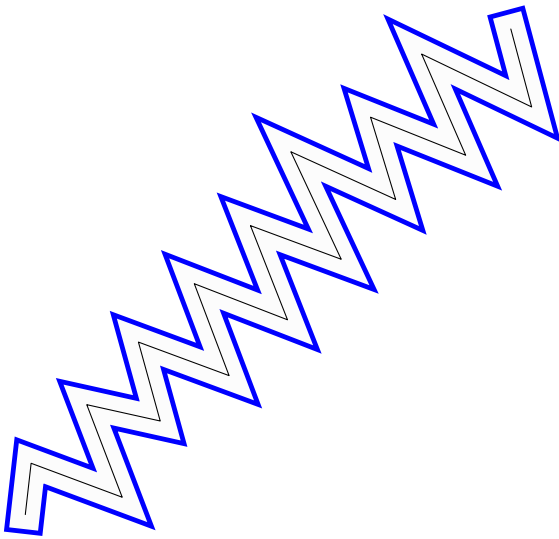

graphexample.1

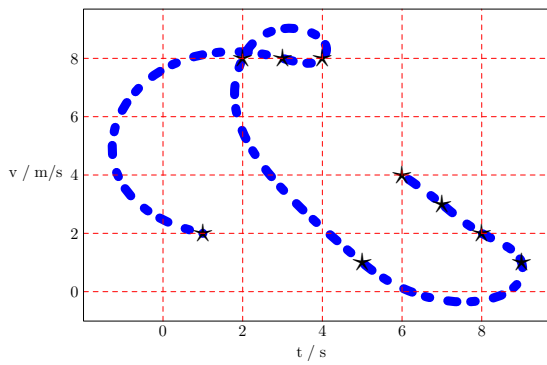

graphs.1

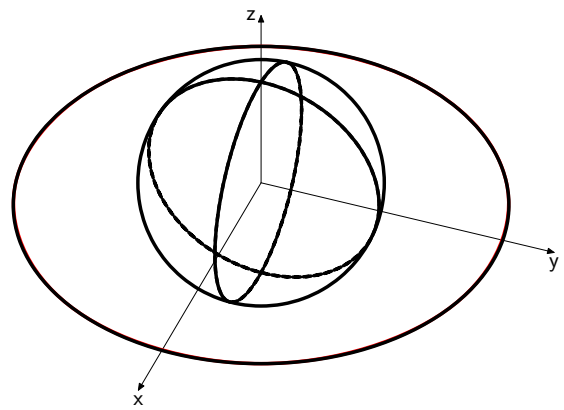

halfcirclesfear.1



hap.1

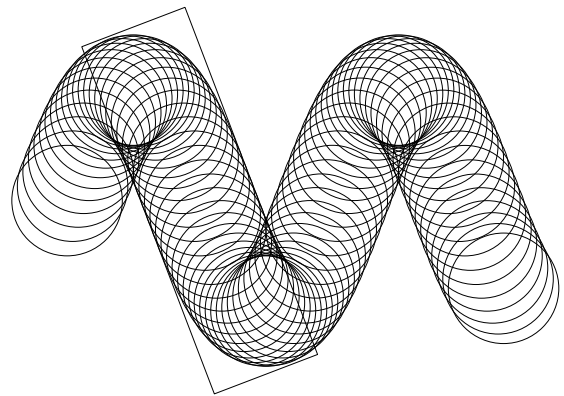

helix.1

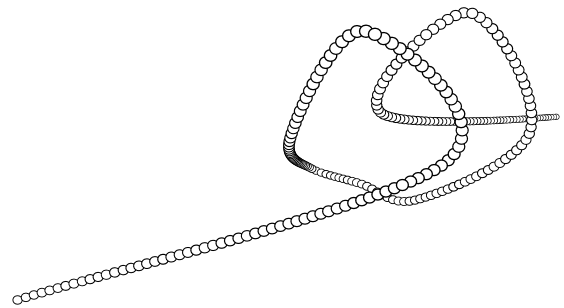

hermitespliknot.1

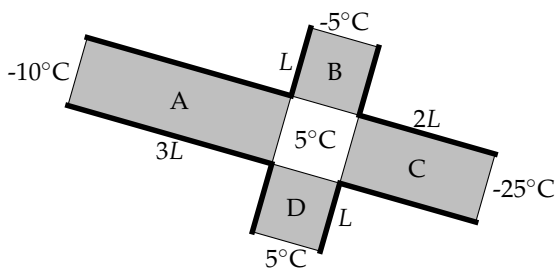

heatfromroom.1

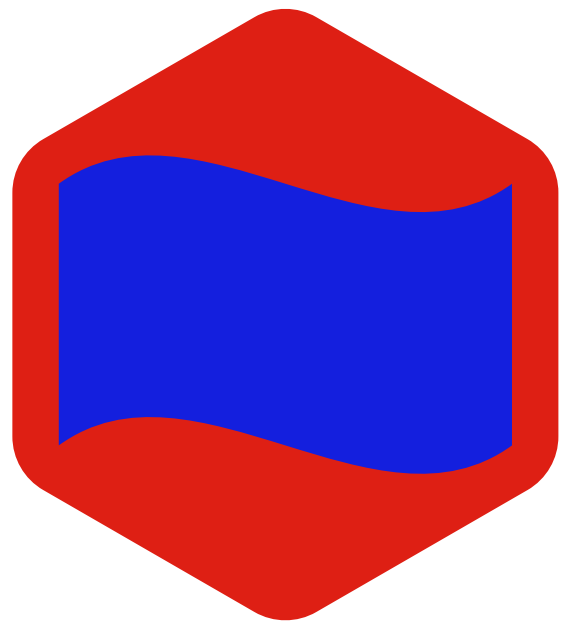

hexacylon.1

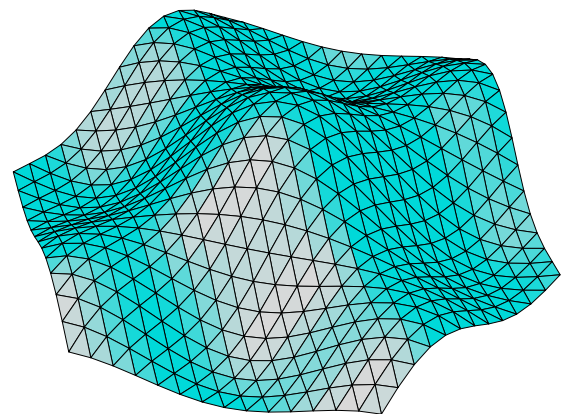
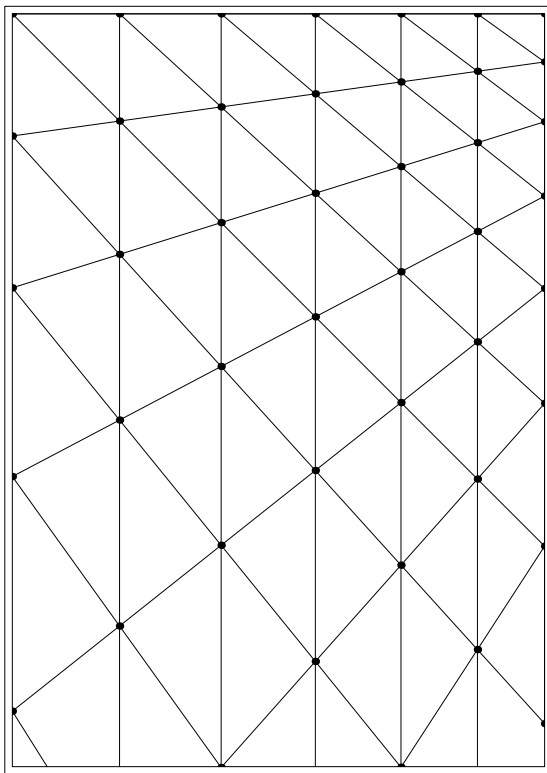
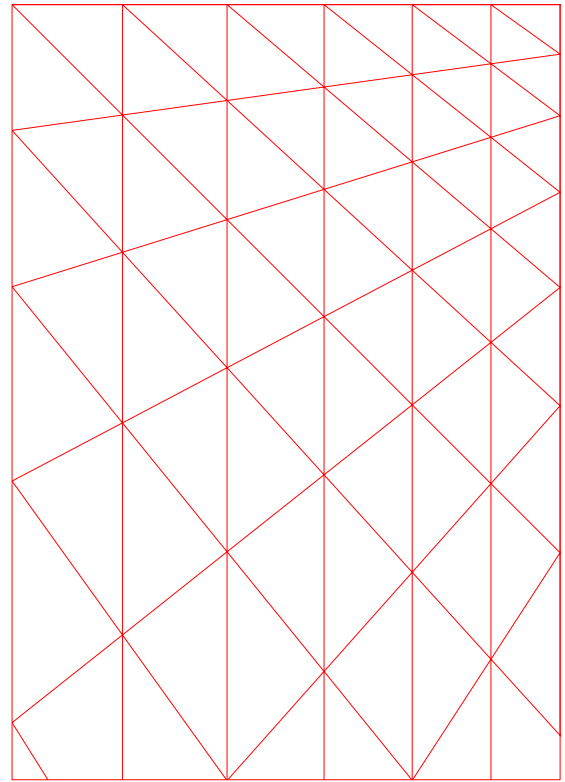
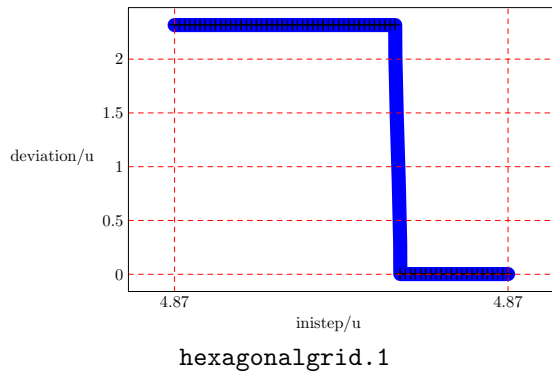

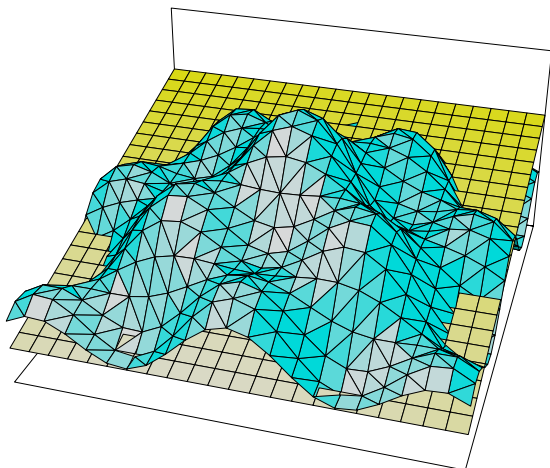

hiddenlinegraph.1

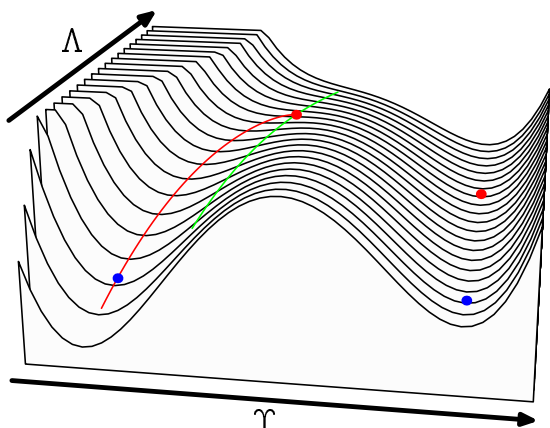

hiddensurface.1

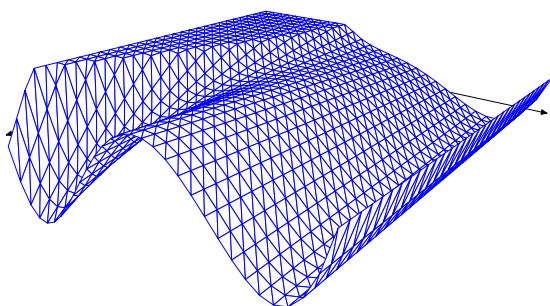

hiddensurfaces.1

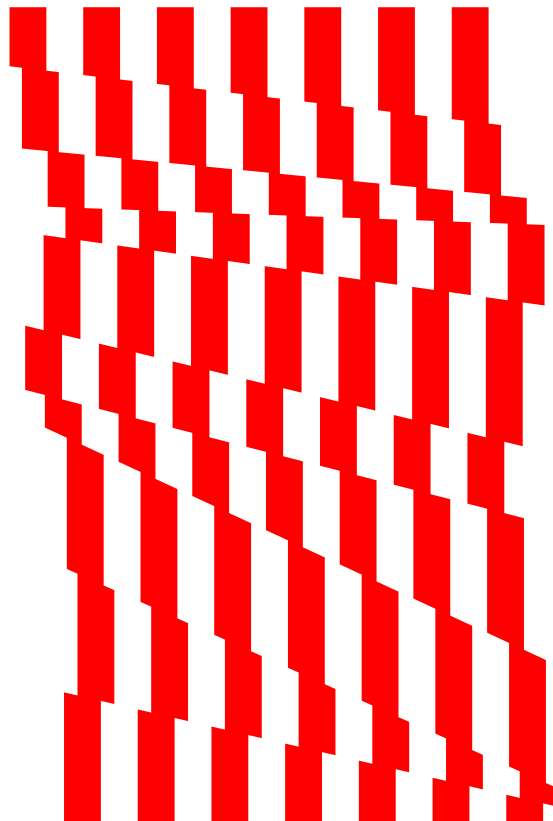

iamsorrykarl.1

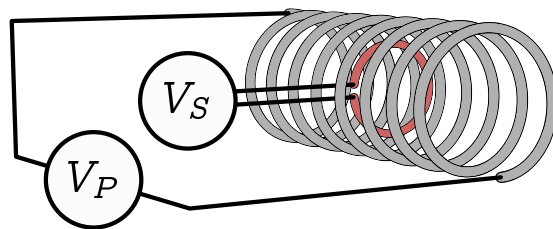

inductionbob.1

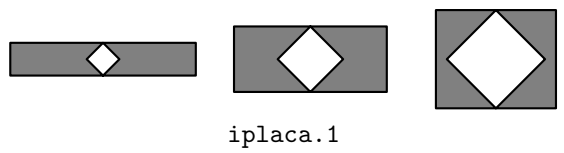
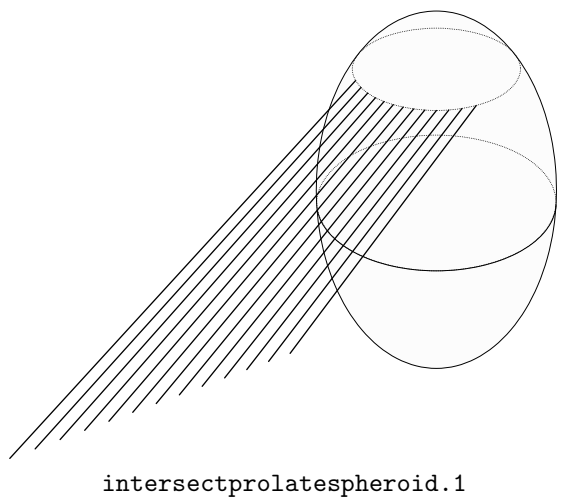
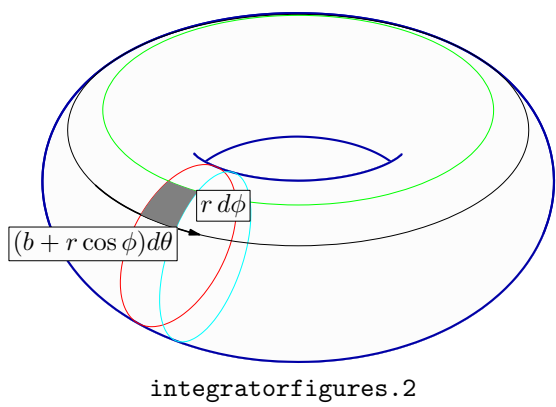
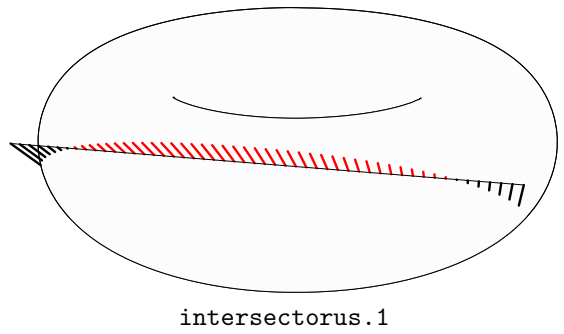
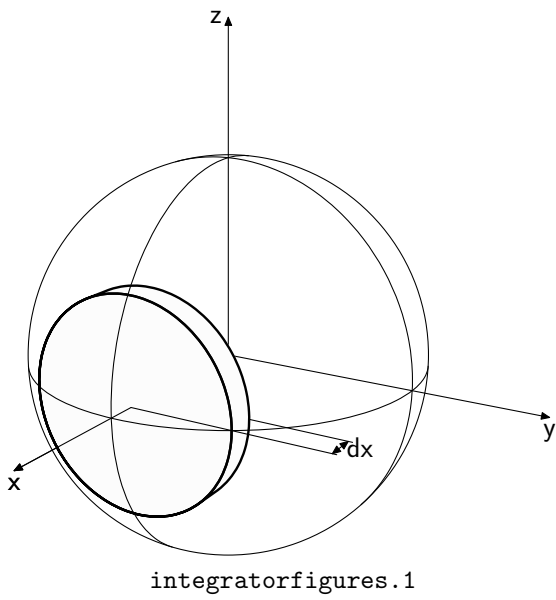
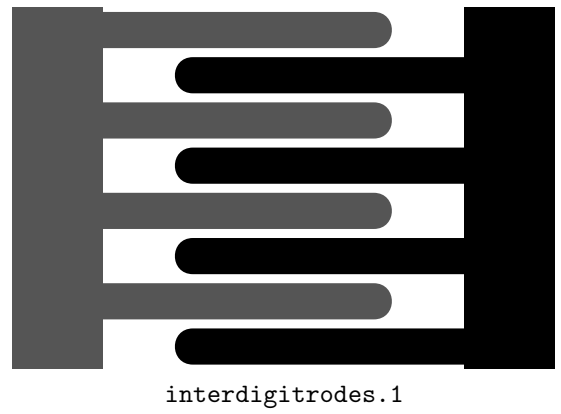
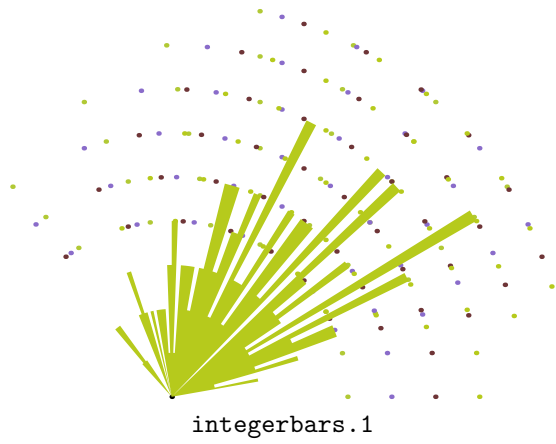



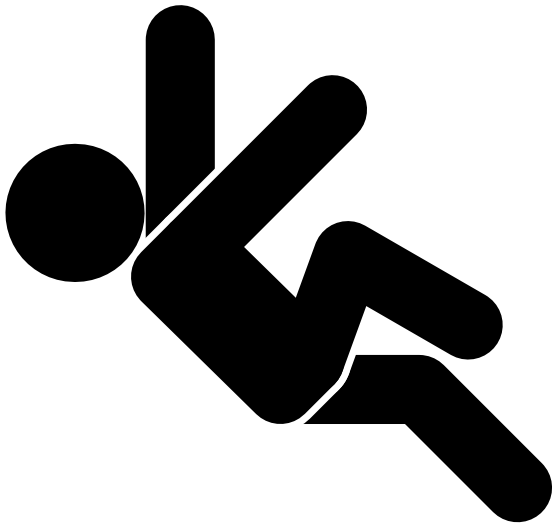

jd44.1



jd44.3



jd44.2



jd44.4



jdbug.1

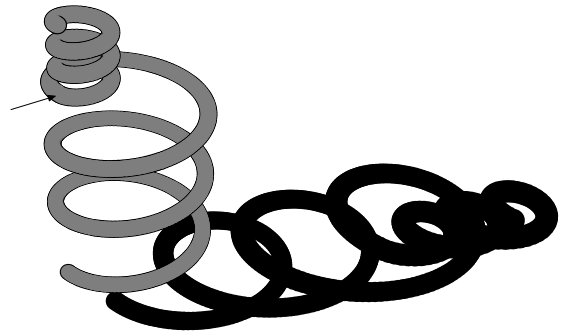

joinedemptylines.1

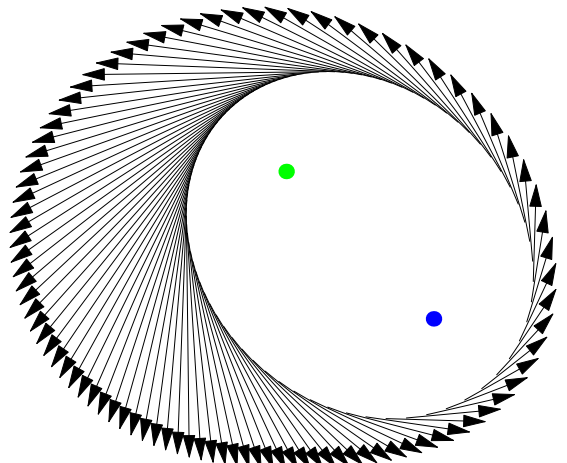

keplernewtonfeynman.1

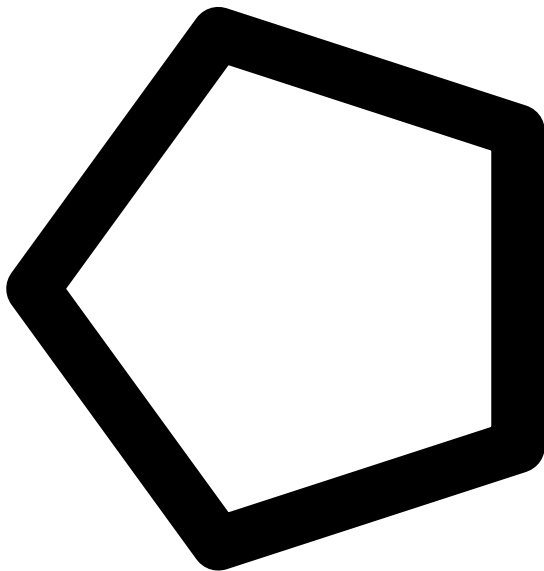

jdbug.2

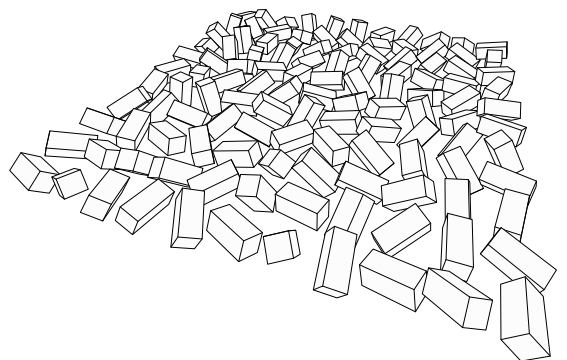

kindofcube.1

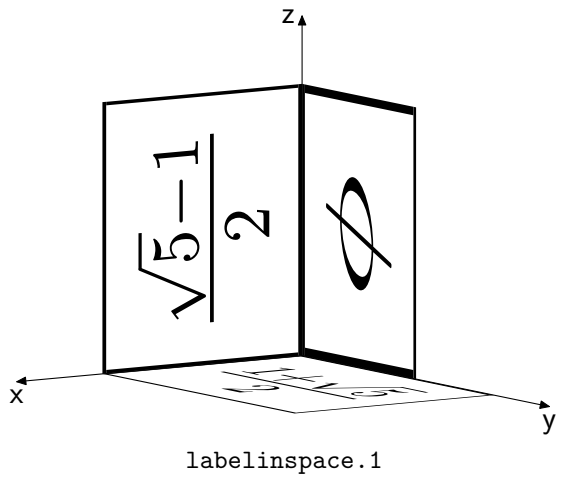
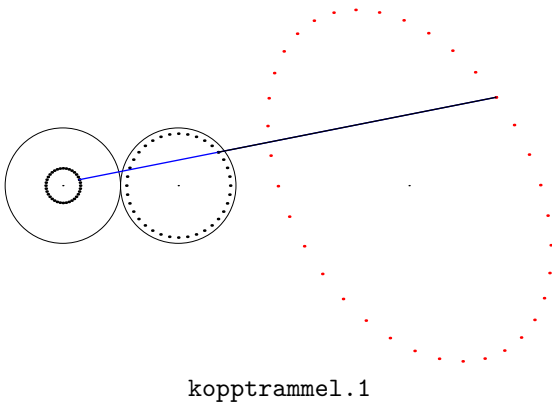
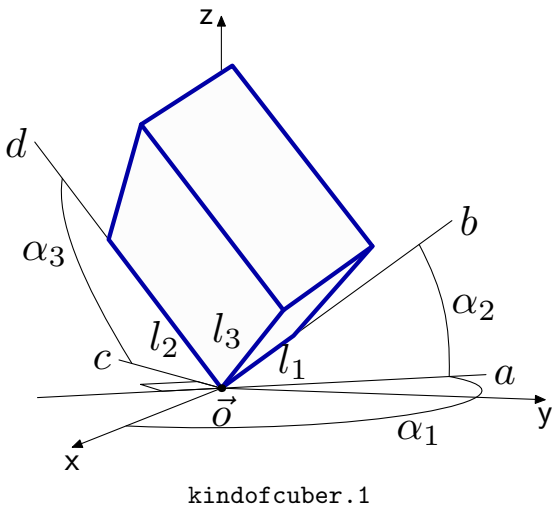
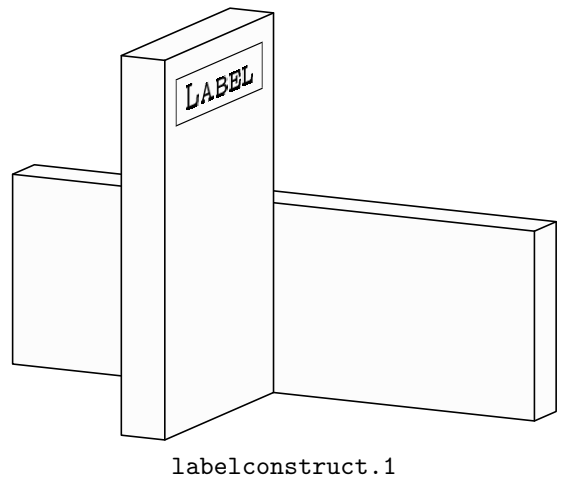
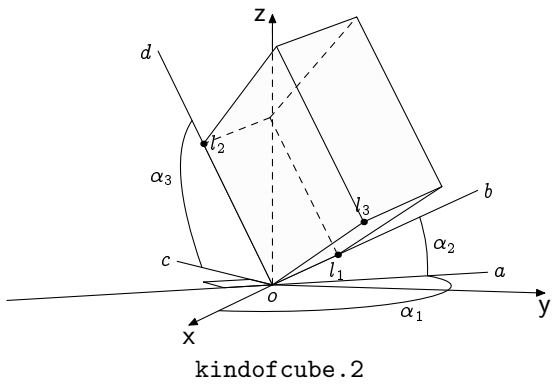



lamarquejaune.1



latexboxes.0



latexboxes.1

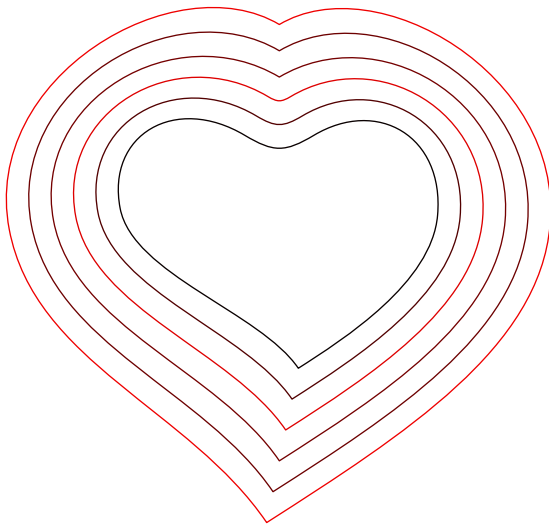

lasermachine.1

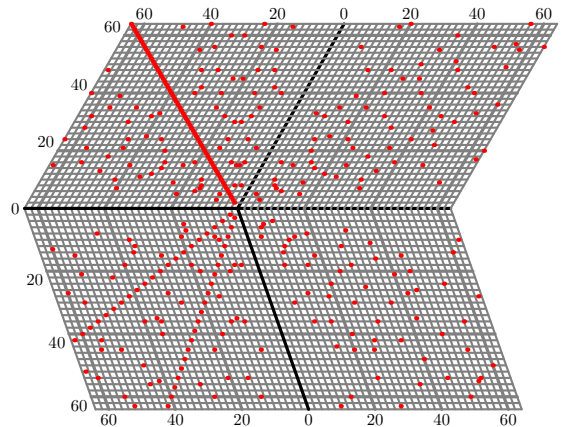

lawofcosines.1

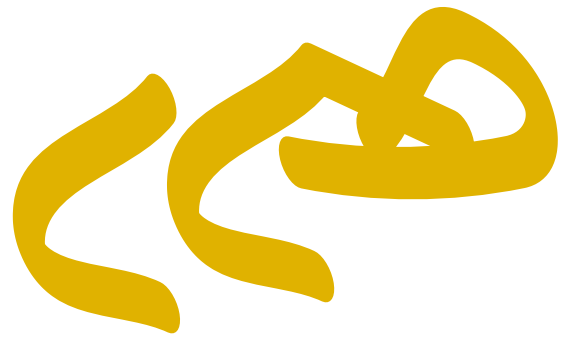
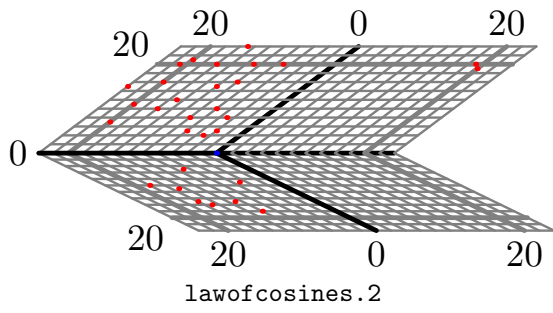

ledlogo.1

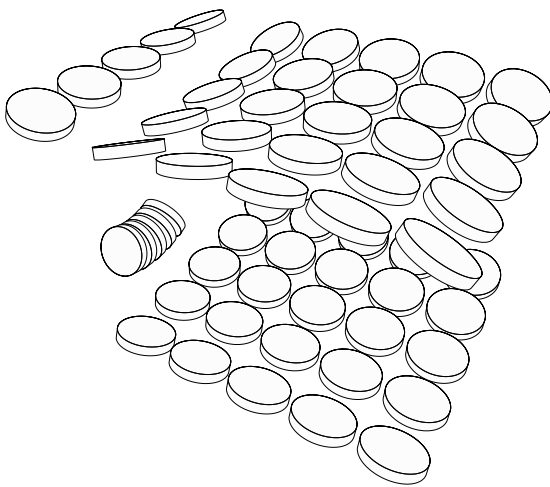

lcurvature.1

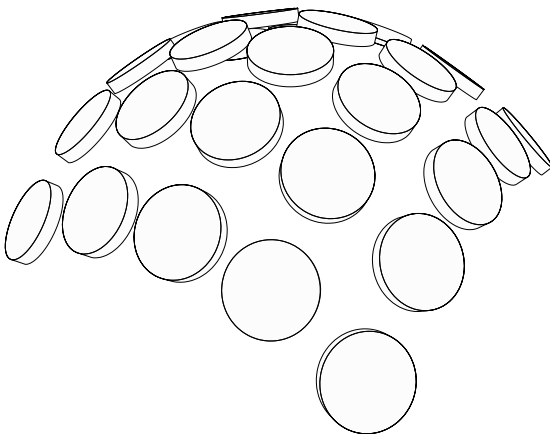

lcurvature.2



ledlogo.2

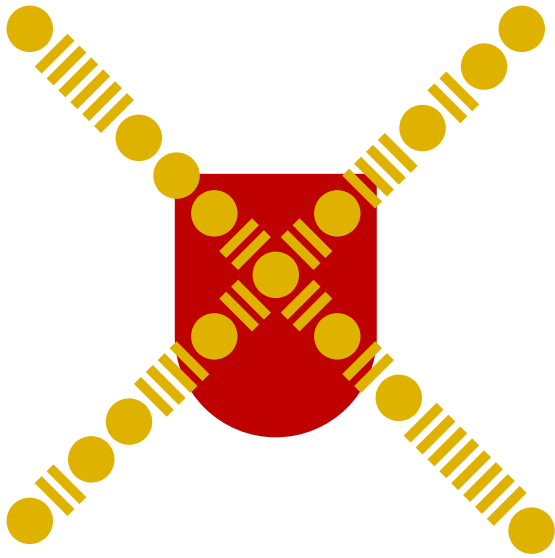

ledlogo.3

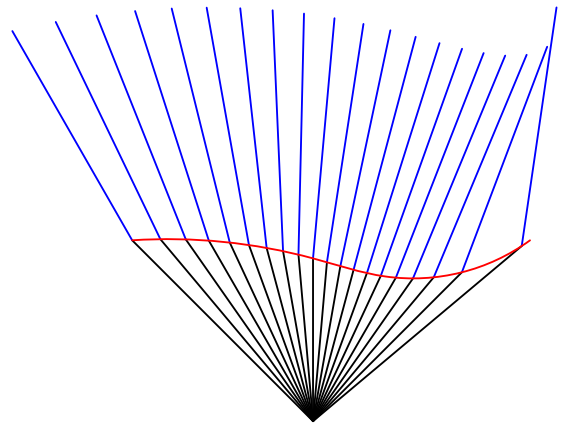

lgc2refractionEdited.1



ledlogo.4

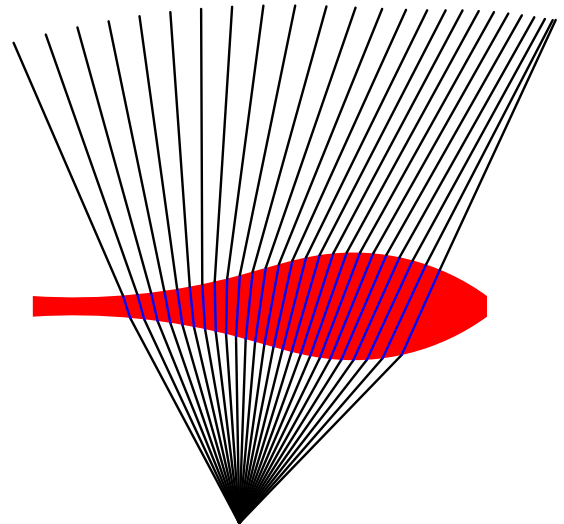

lgc2refractionEdited.2

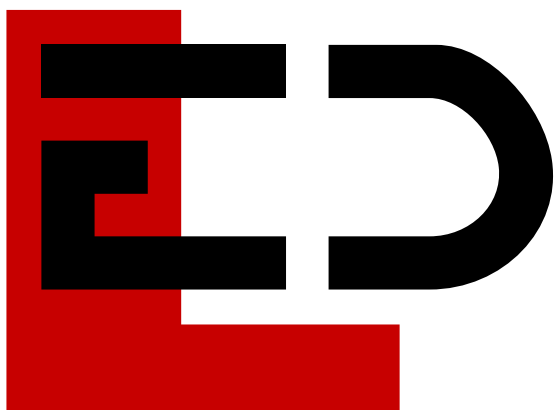

LED.1

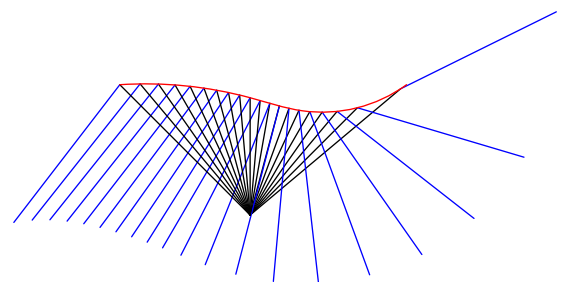

lgc2refractionEdited.3

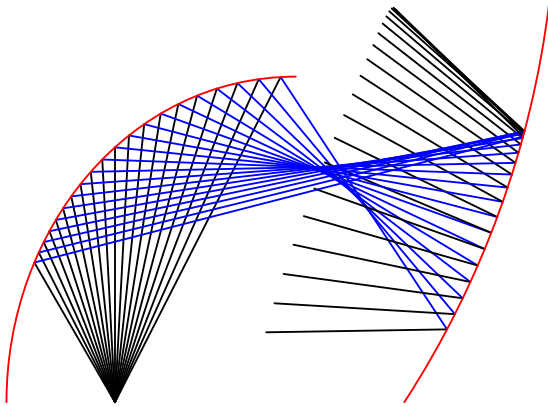

lgc2refractionEdited.4

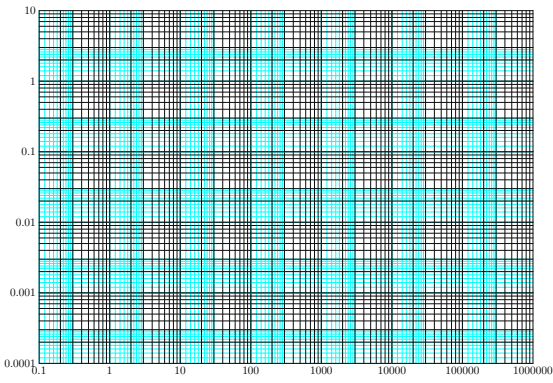

loglogpaper.1

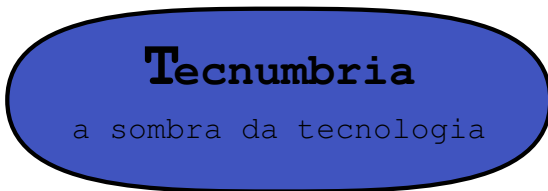

logofontest.0

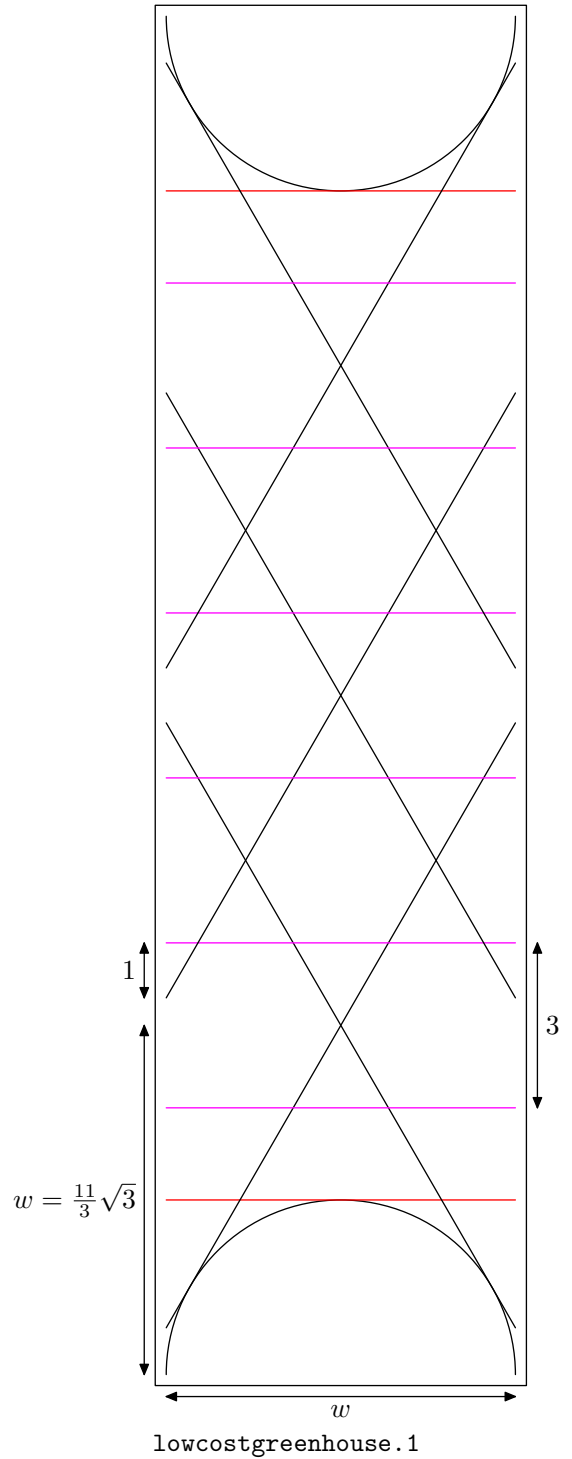

lowcostgreenhouse.1

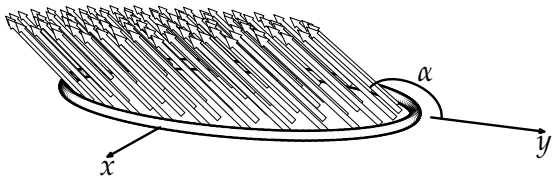

magneticflux.1

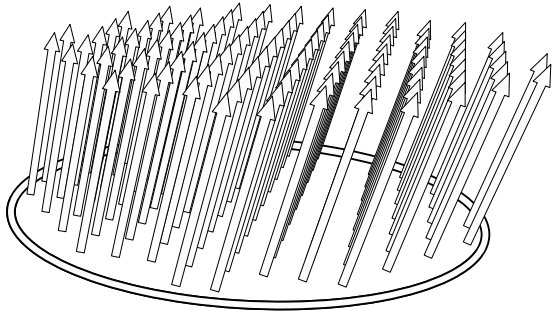

magneticflux.2

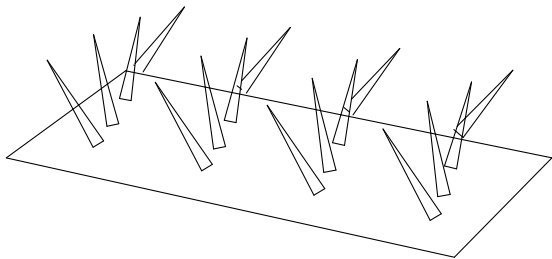

mainmentest.1

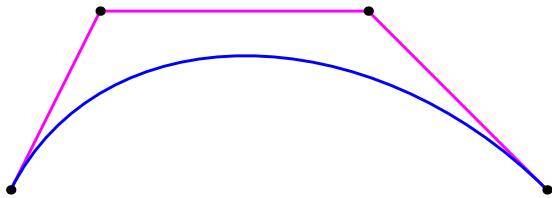

manjusha.1

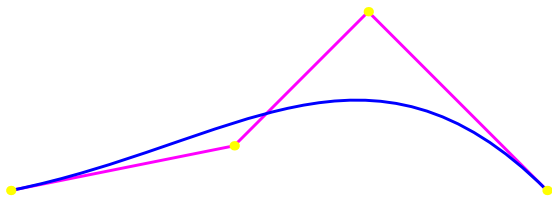

Degree 3

manjusha.4

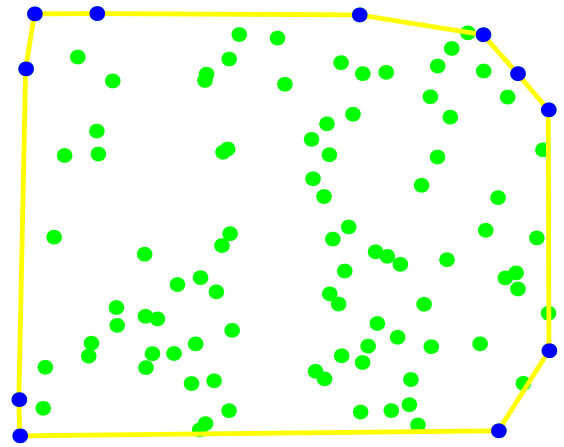

manjusha.6

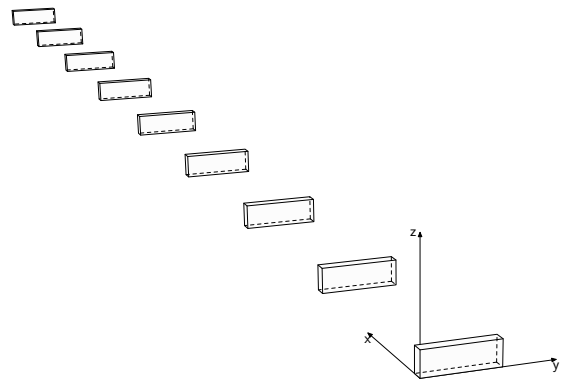

matricskoc.1

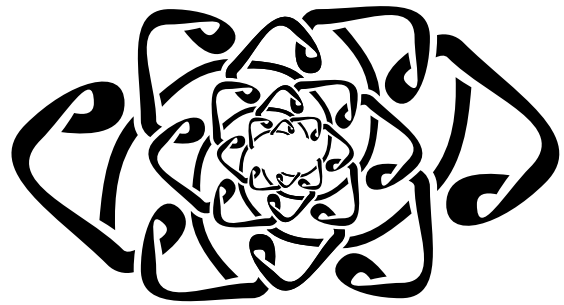

mce-lng.1



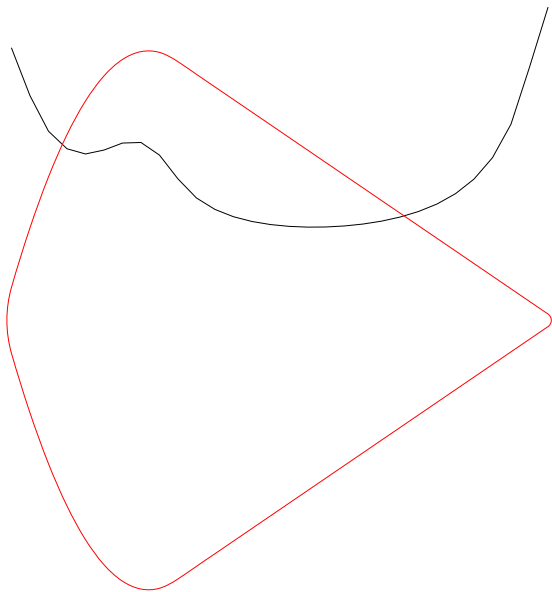

metalcharge.1

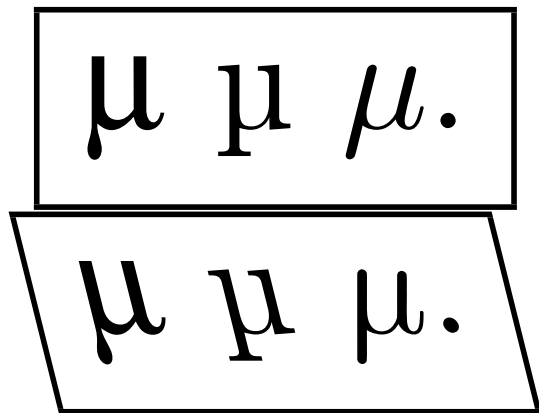

micromu.1

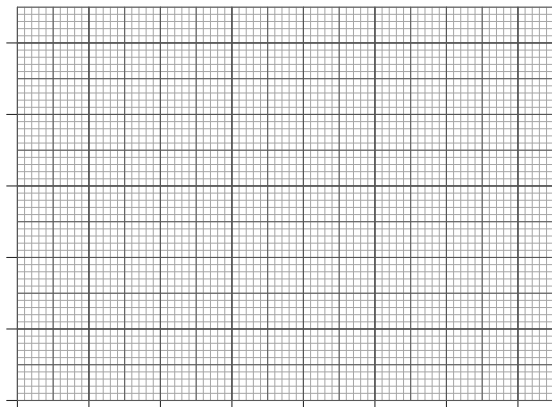

milimetricpaper.1

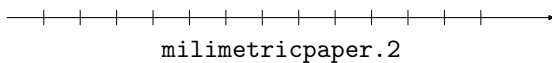

milimetricpaper.2

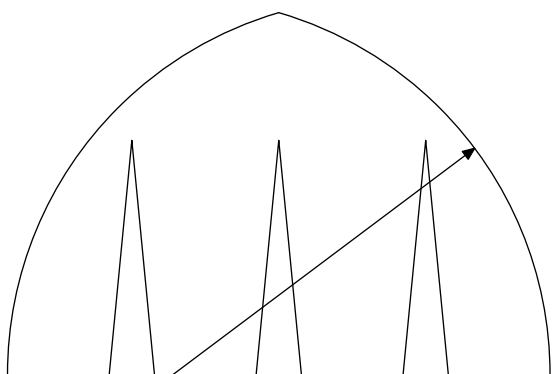

micostufas.1

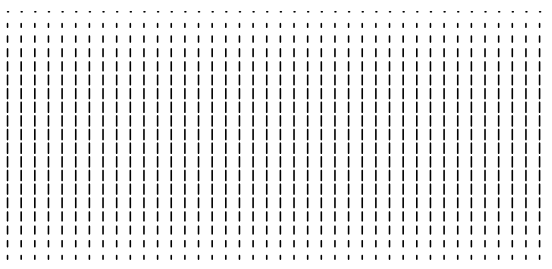

mpfields.0

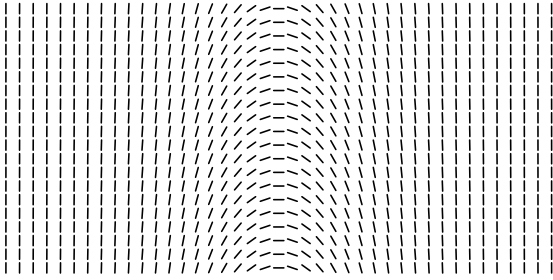

mpfields.1

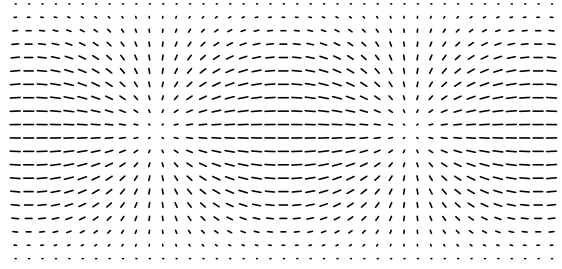

mpfields.5

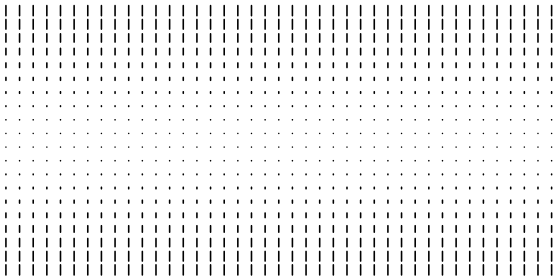

mpfields.2

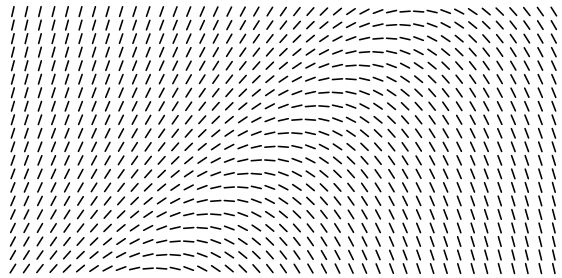

mpfields.6

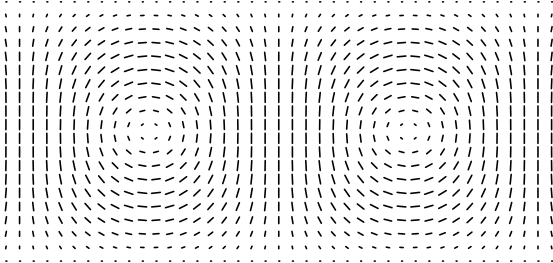

mpfields.3



mpfields.4

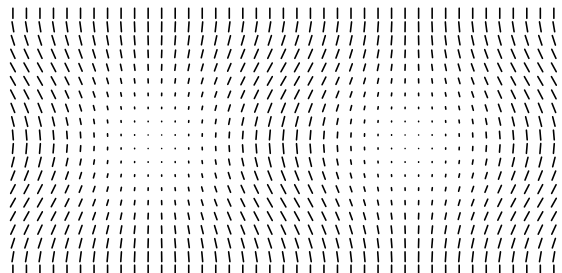

mpfields.7

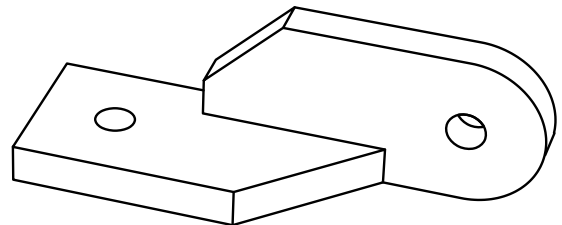
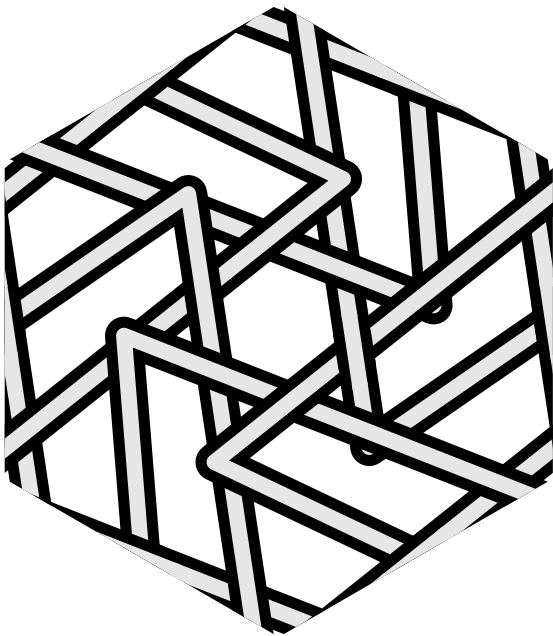
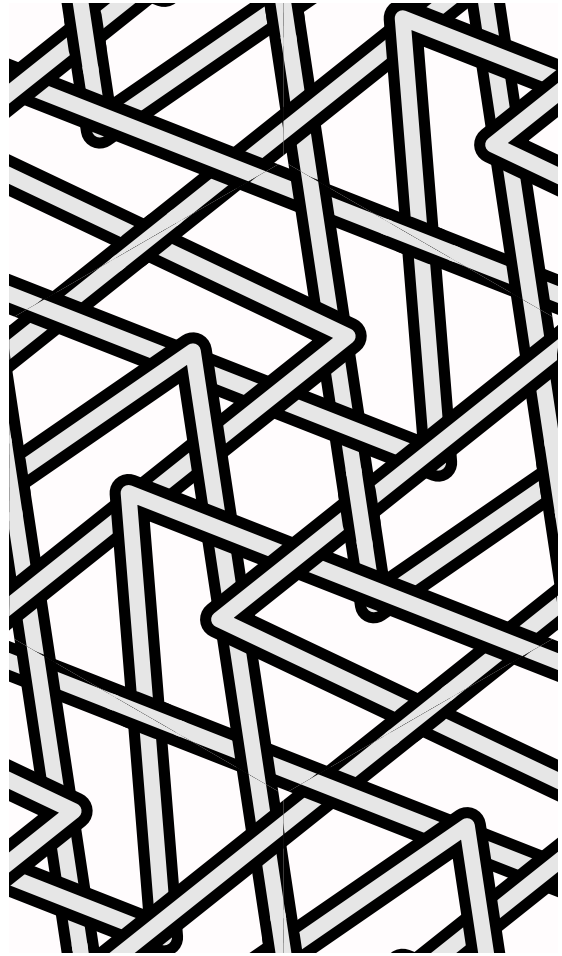
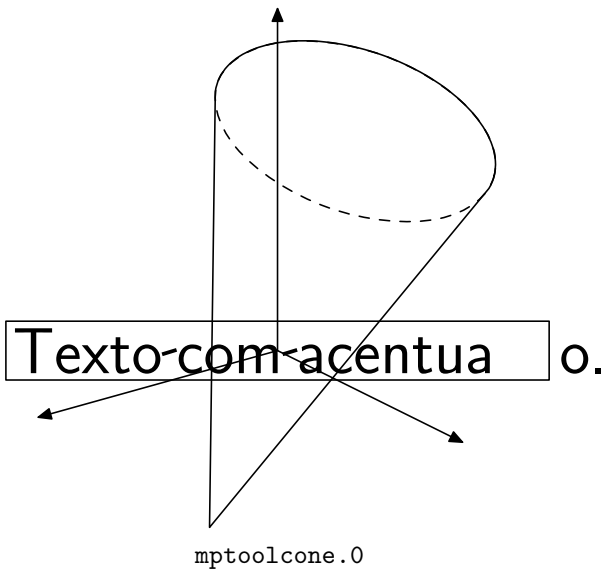

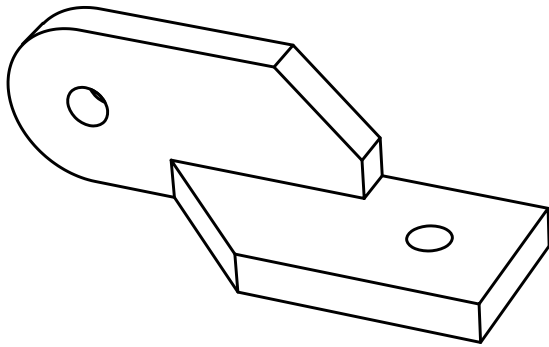

mypatent.2

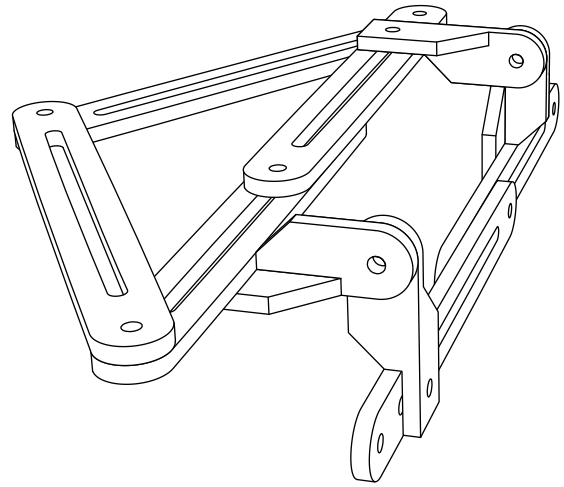

mypatentpieces.1

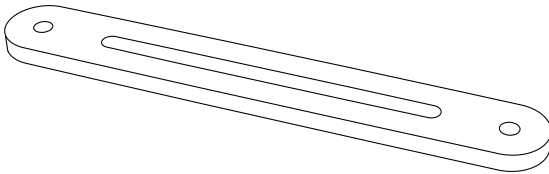

mypatent.3

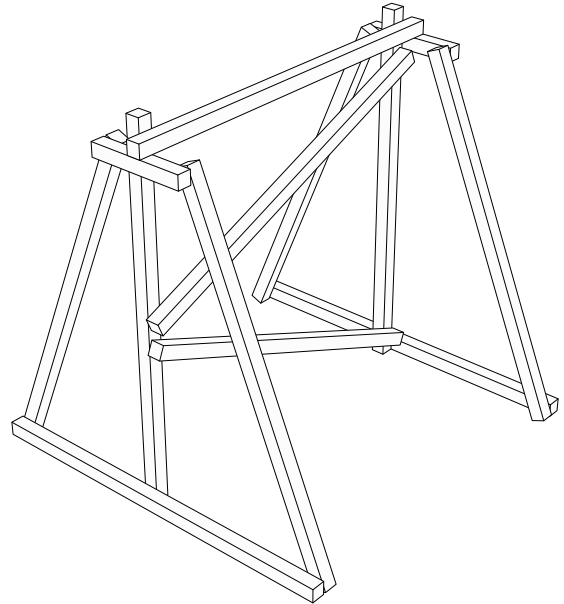

mysquaresectionbar.1

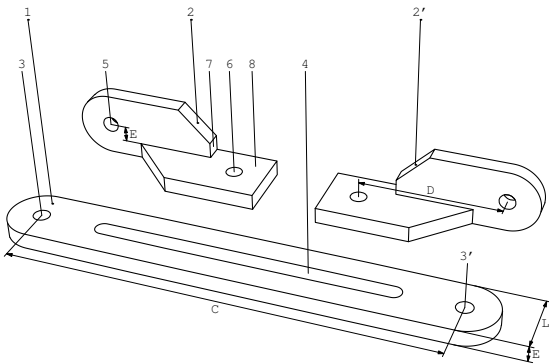

mypatent.4

NÃO  
estacionar

naoestacionar.1

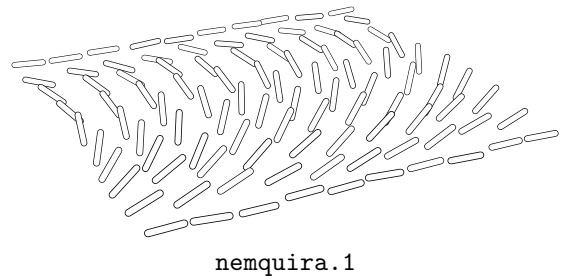
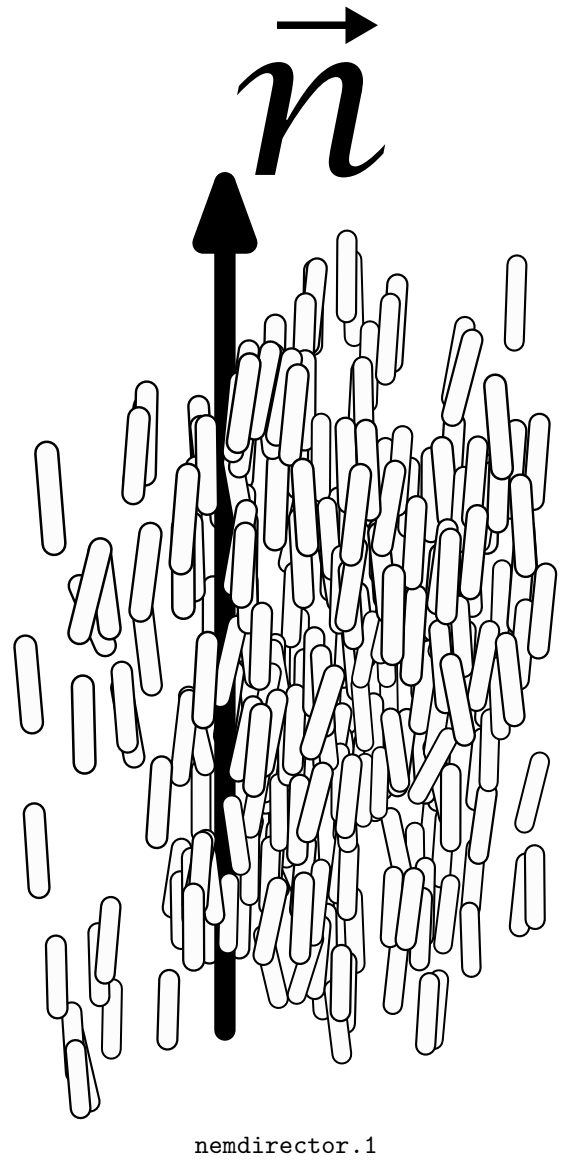
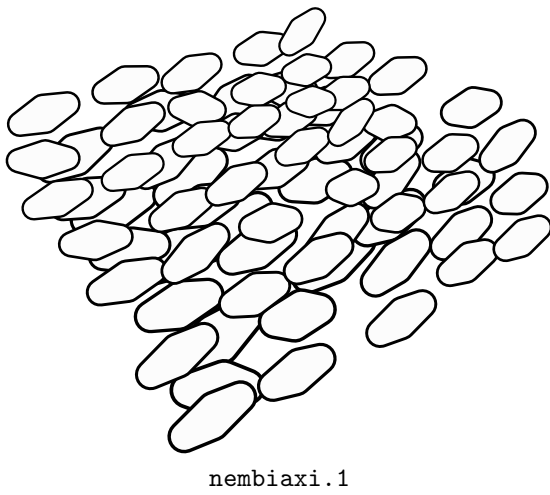
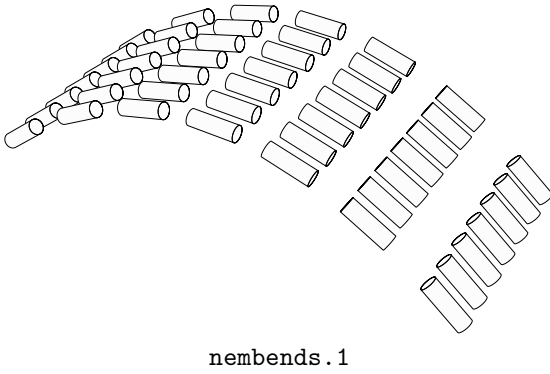
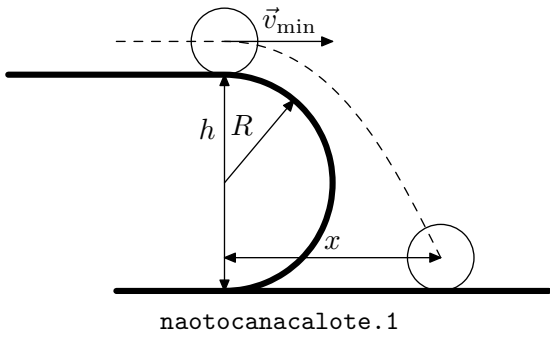

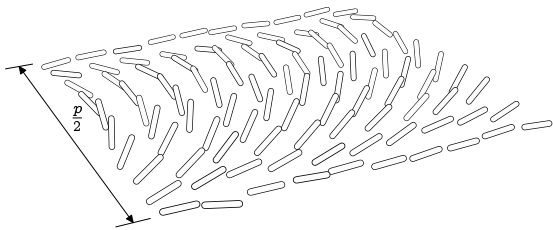

nemquirapitch.1

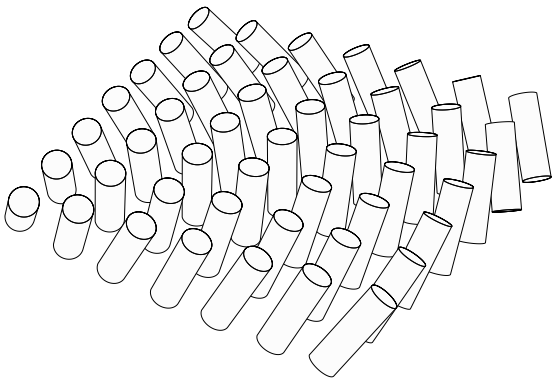

nemsaddl.1

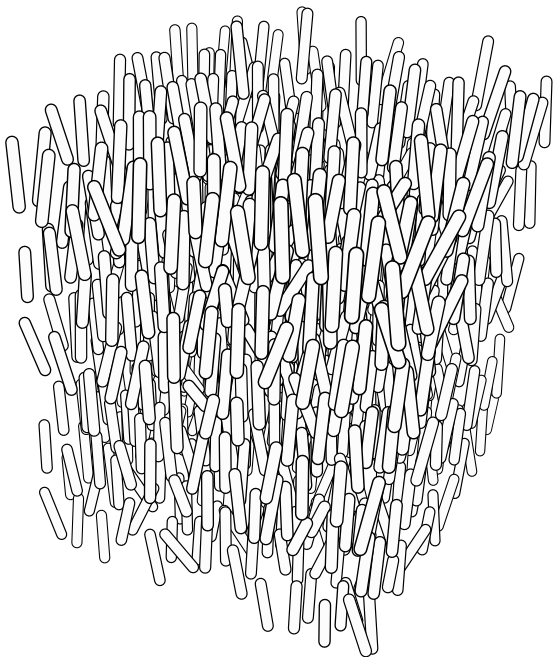

nemuniax.1



newcommunism.1

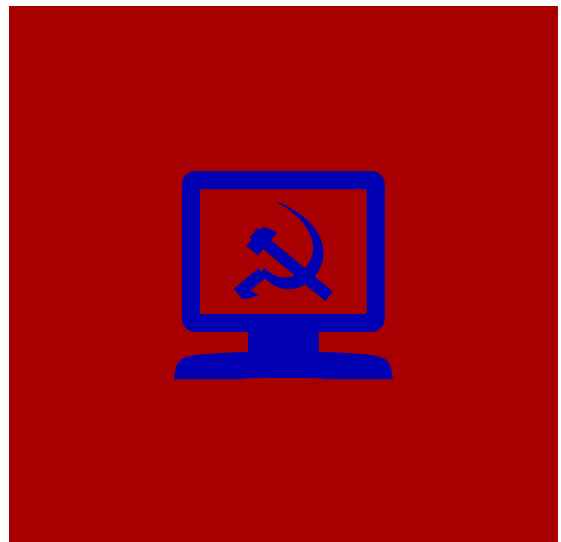

newcommunism.2

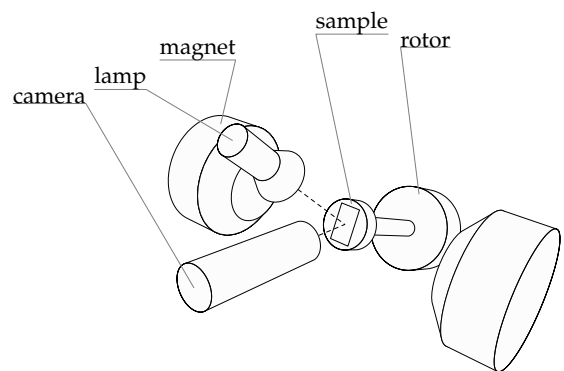

newexperimental.1

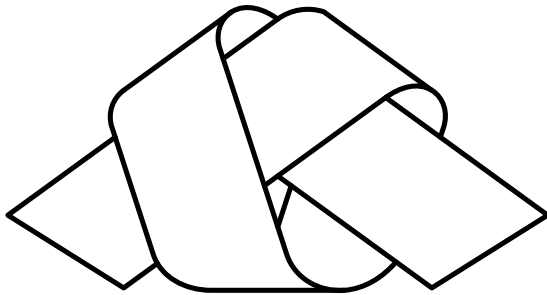

nosimples.1

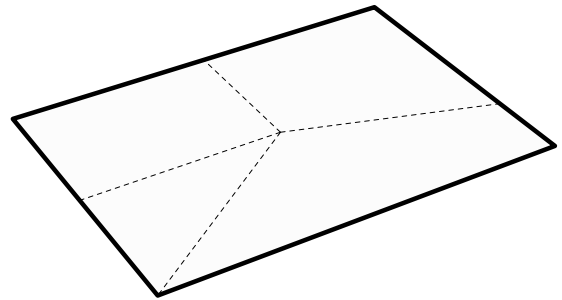

nulldefectangleexample.1

**N**   
**SUSPENSION**  
**BIKES**

nosuspension.0

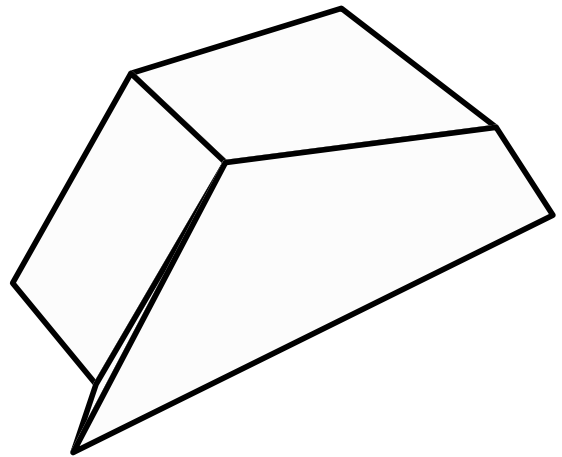

nulldefectangleexample.2

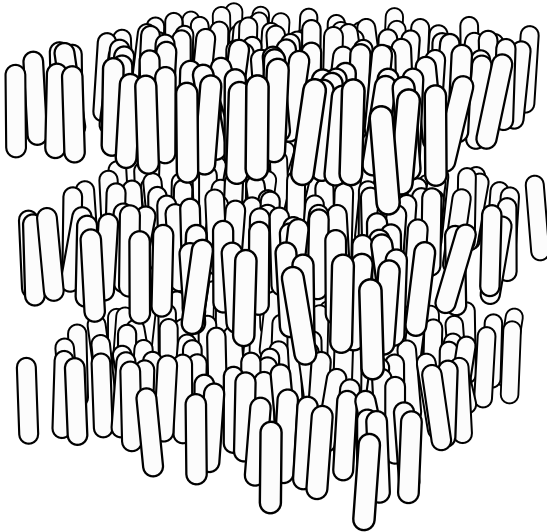

nsmetica.1

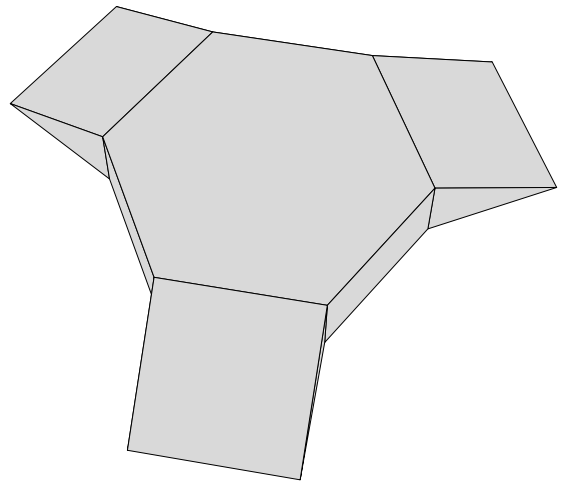

nulldefectangleexample.3

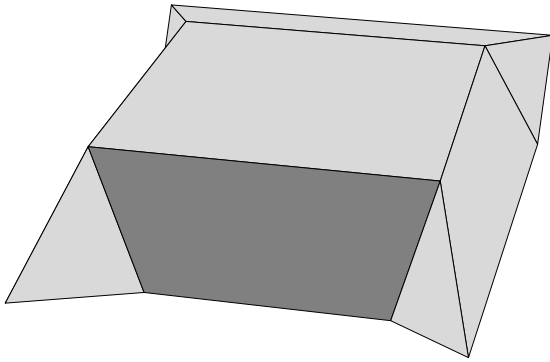

nulldefectangleexample.4

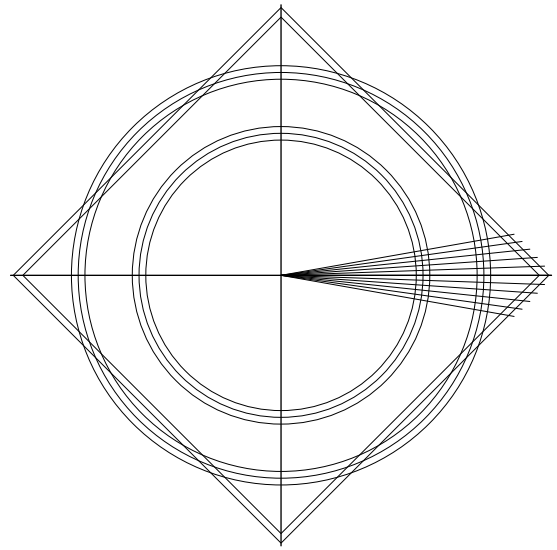

optest.1

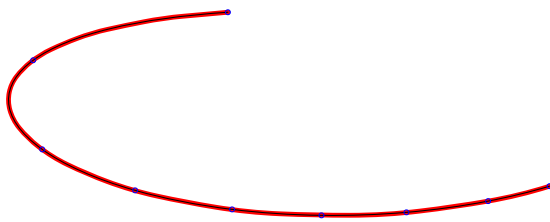

nurbstobeziern.0



onebigword.1

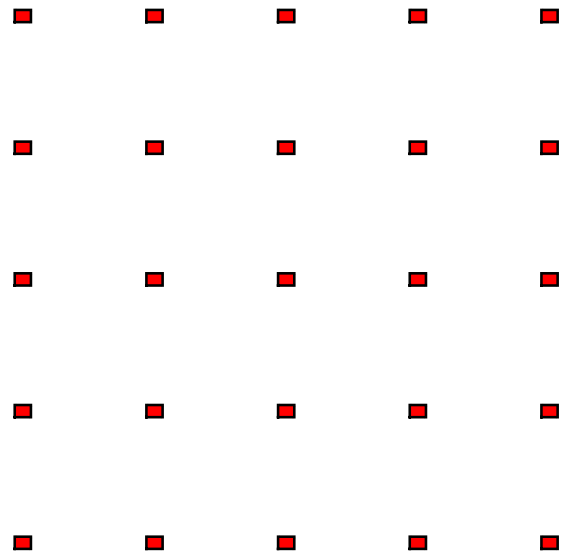

optest.2



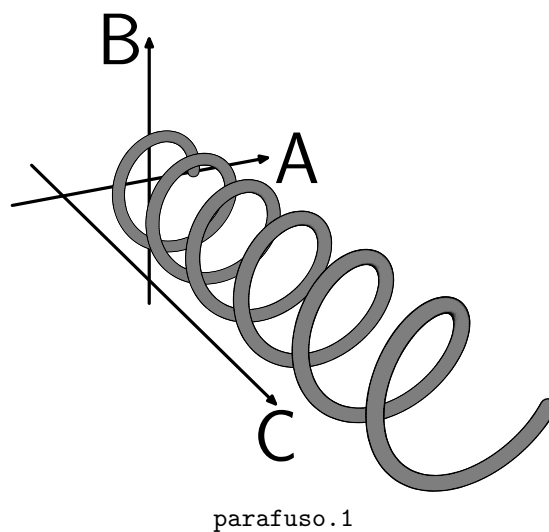
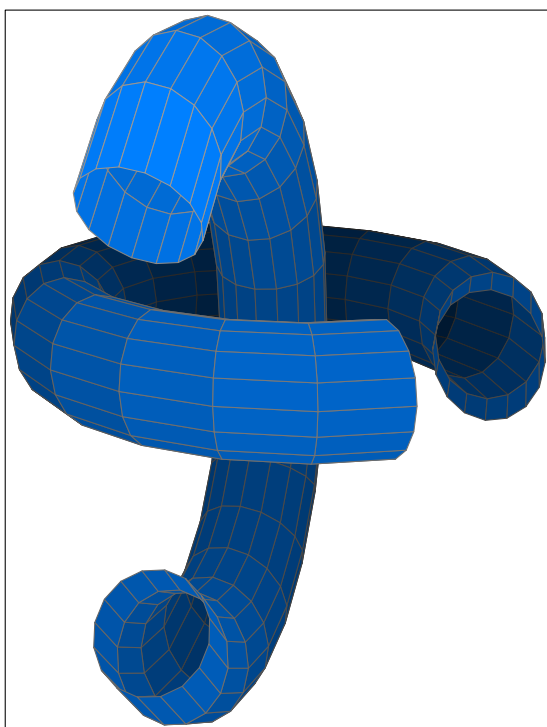
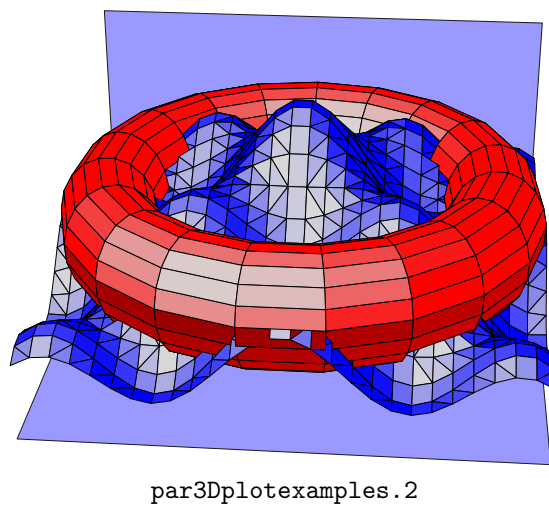
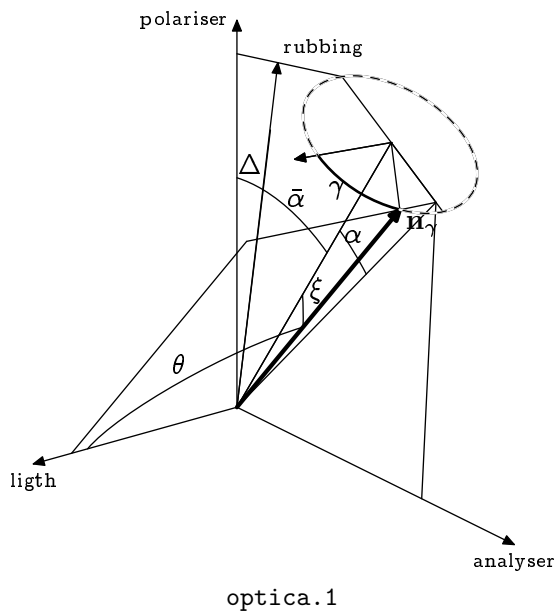

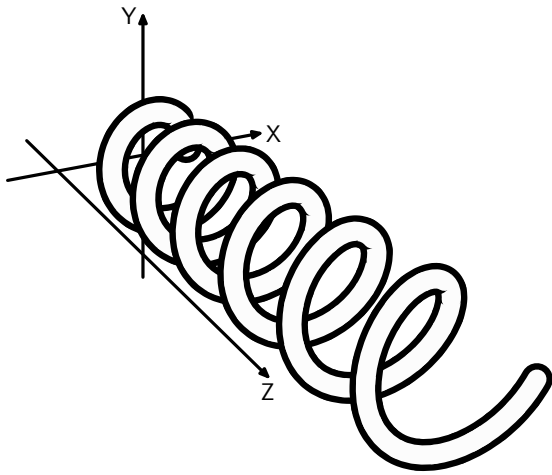

parafuso.2

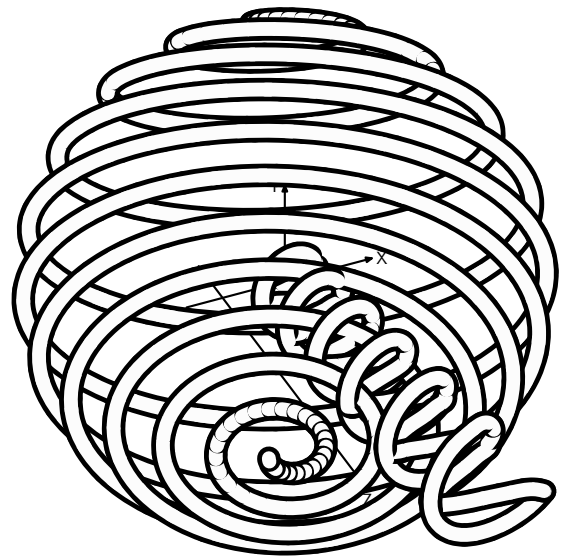

parafuso.4

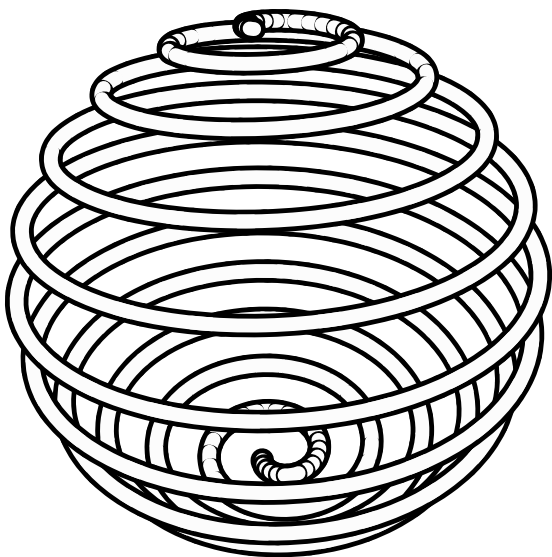

parafuso.3

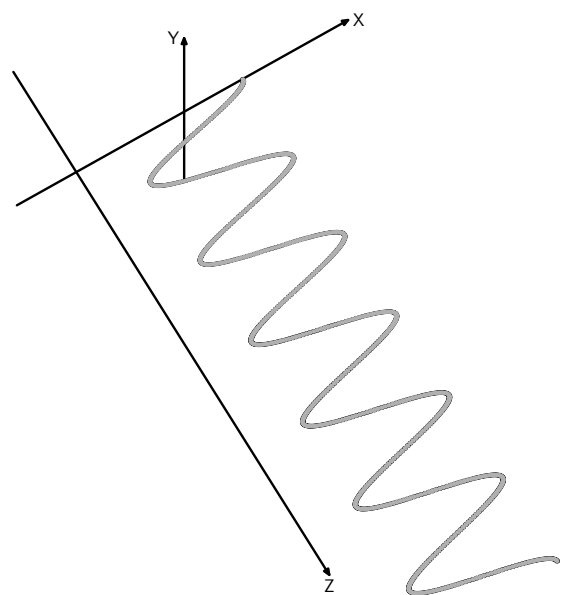

parafusoprojxy.1

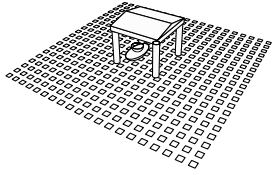

pathernon.0

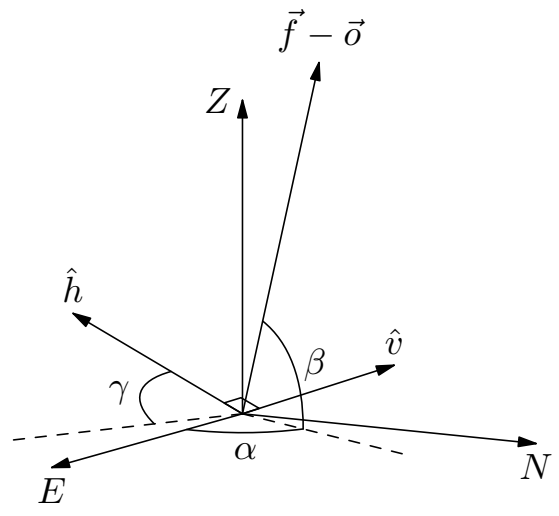

photorefer.1

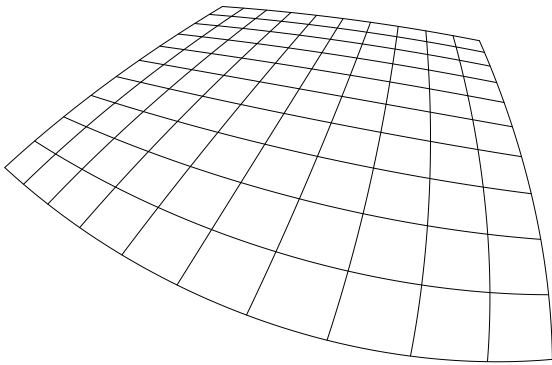

pathofstraightline.1

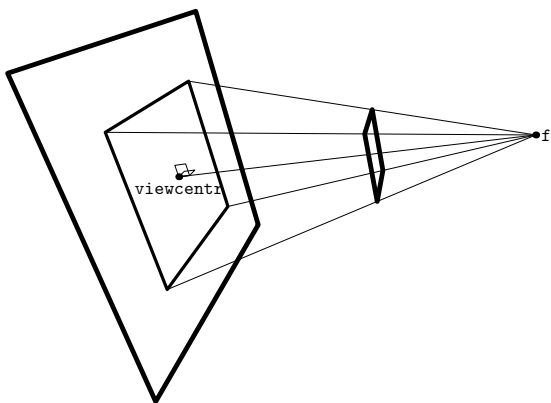

perspec.1

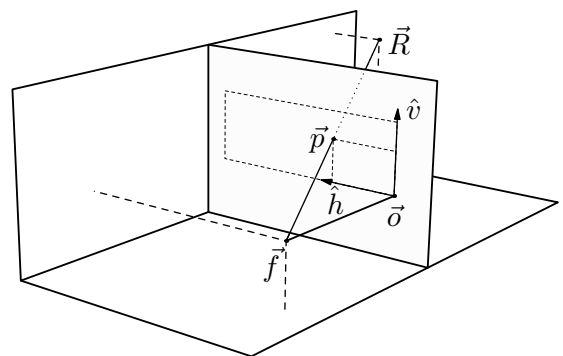

photorefer.2

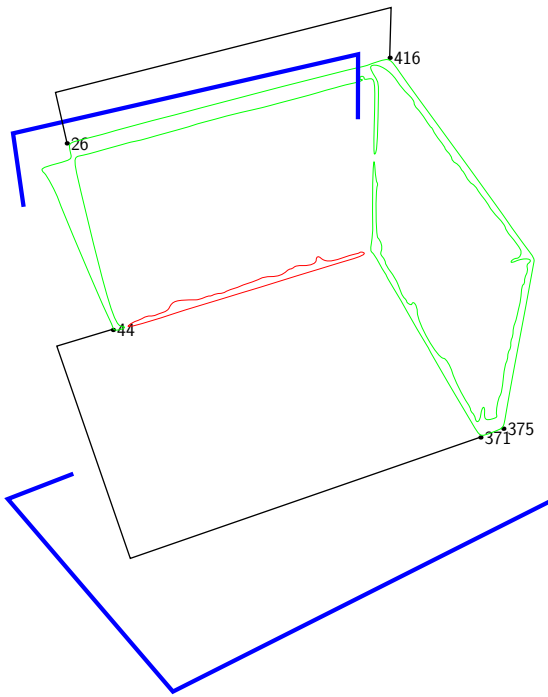

photoreverse.1

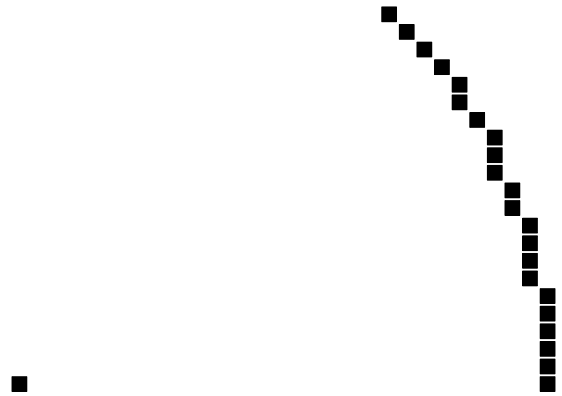

pixelgrid.1

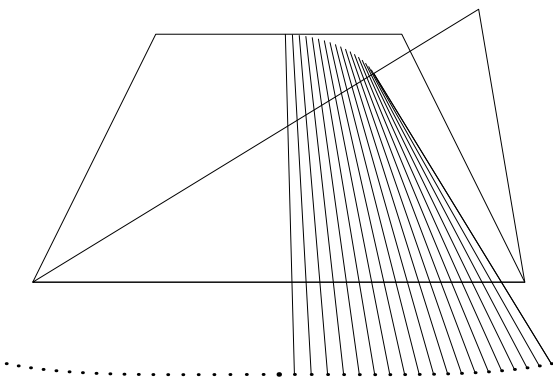

pifpaf.1

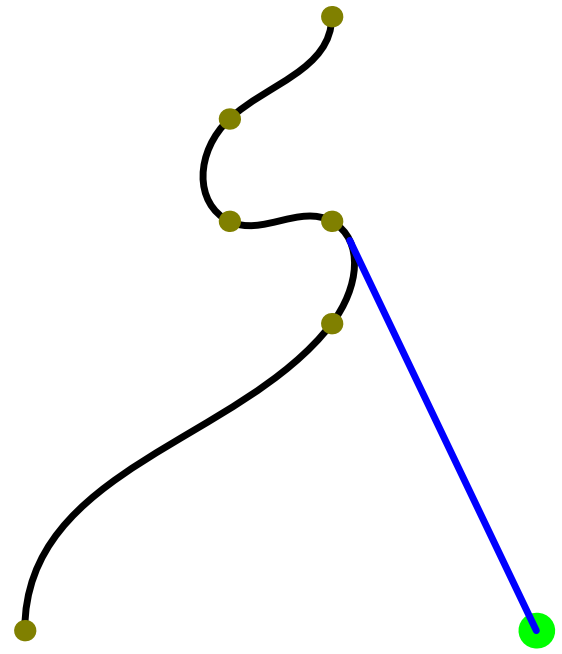

plaintangency.0

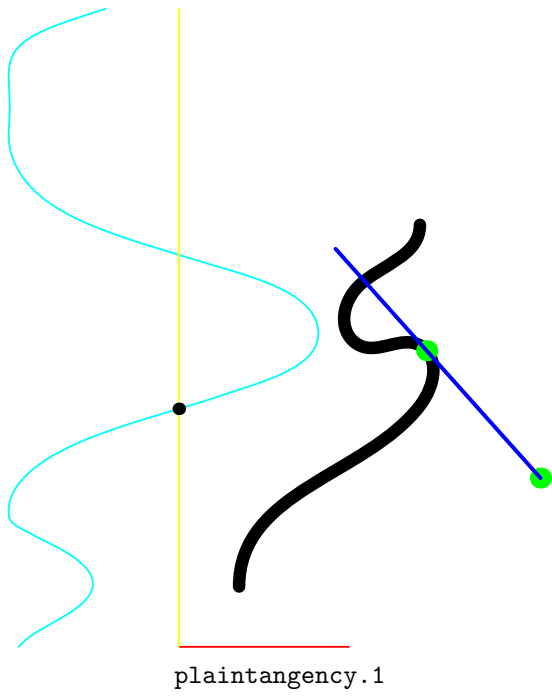

plaintangency.1

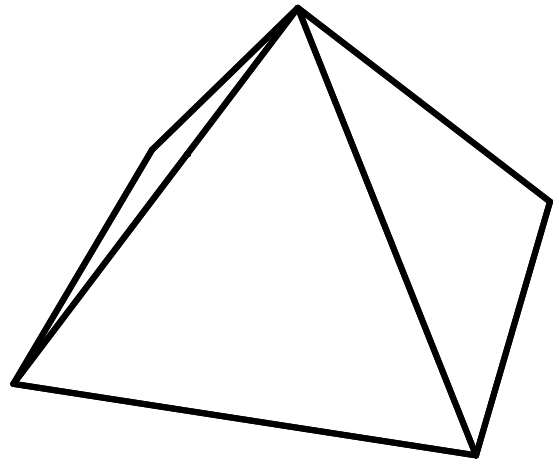

planpht.1

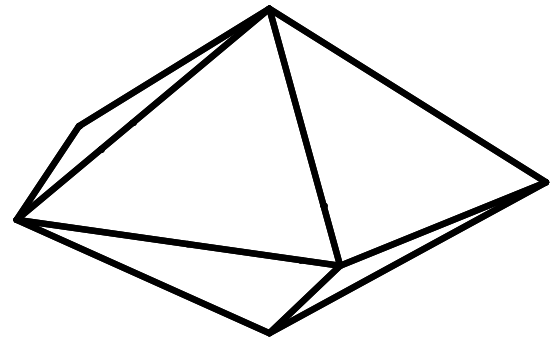

planpht.2

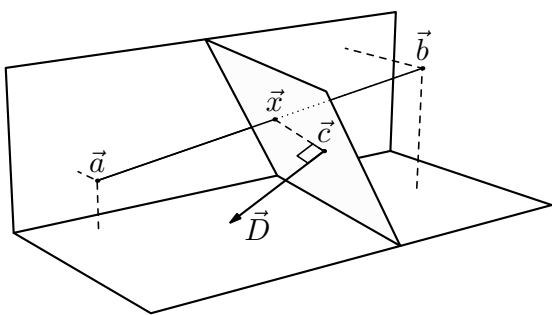

planintersection.1

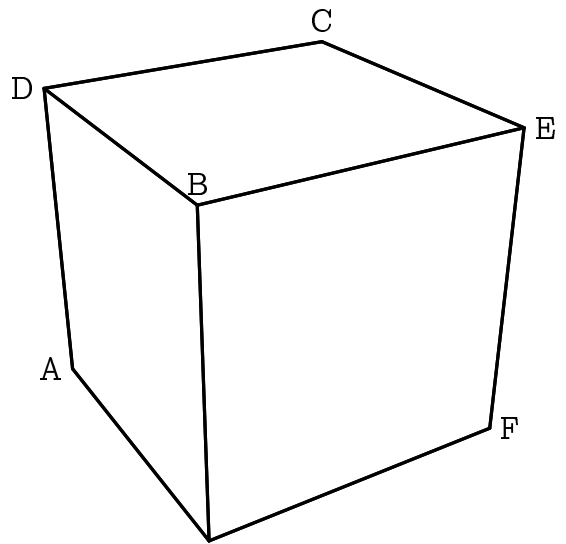

planpht.3

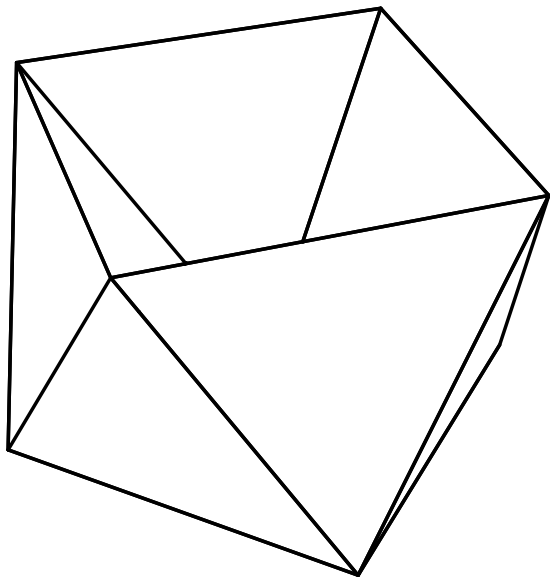

planpht.4

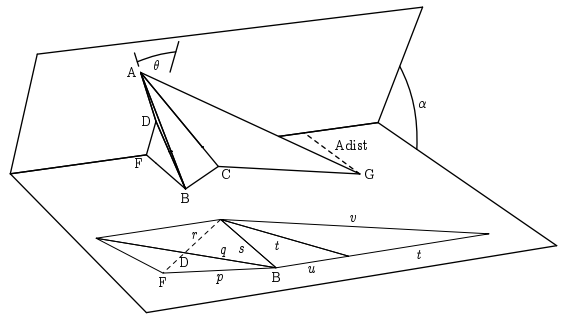

planpht.6

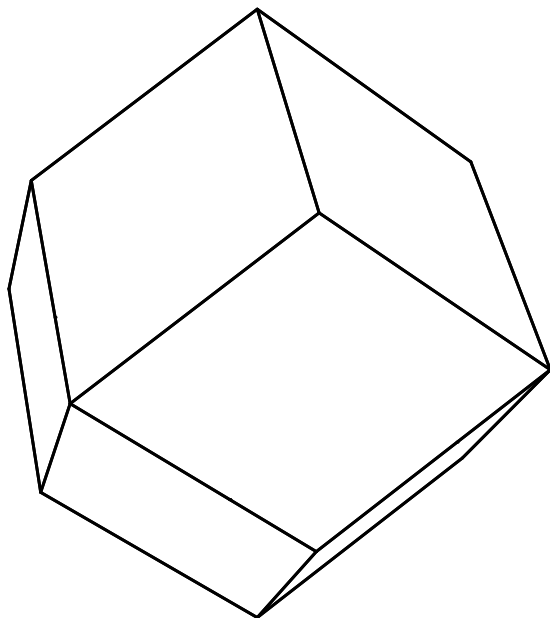

planpht.5

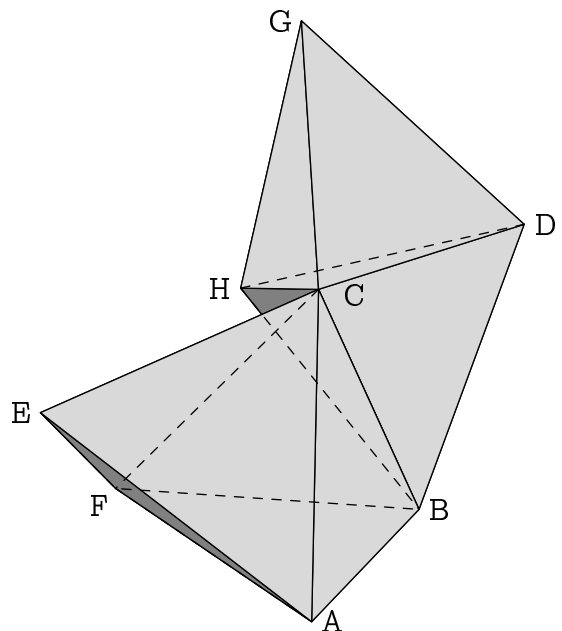

planpht.7

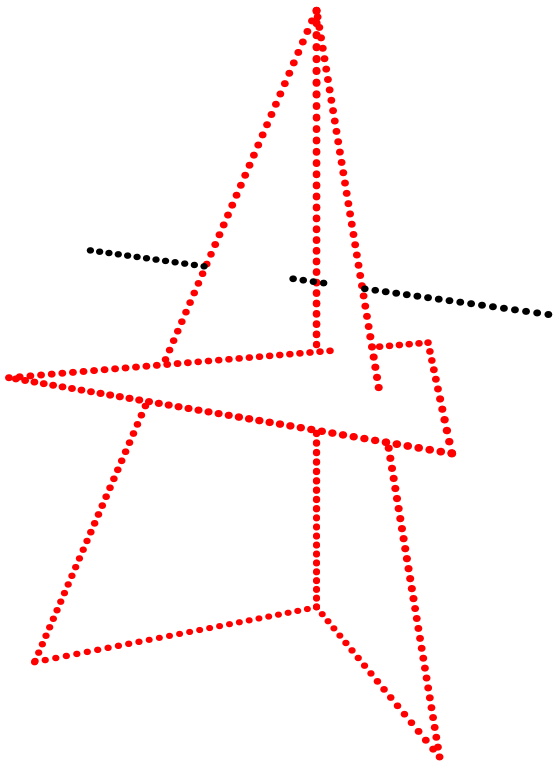

polyhedr.1

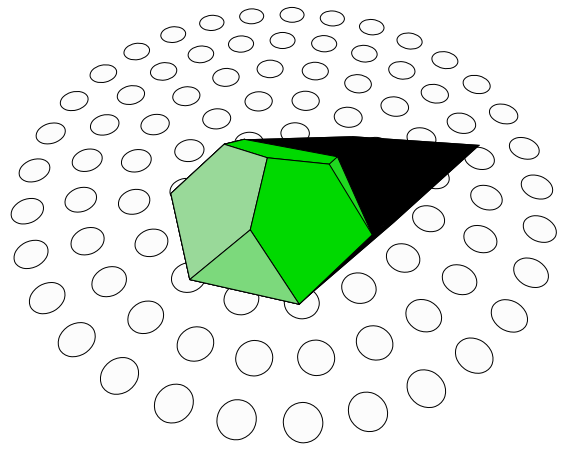

polyhedr.3

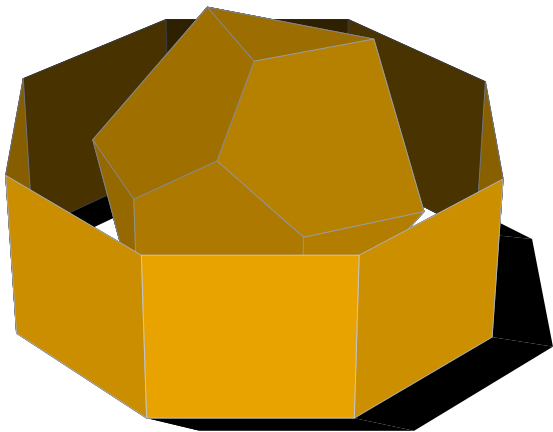

polyhedr.2

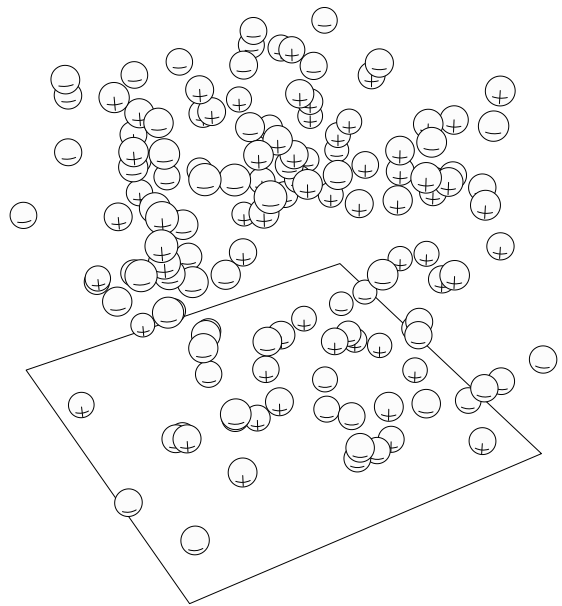

positivecharge.1

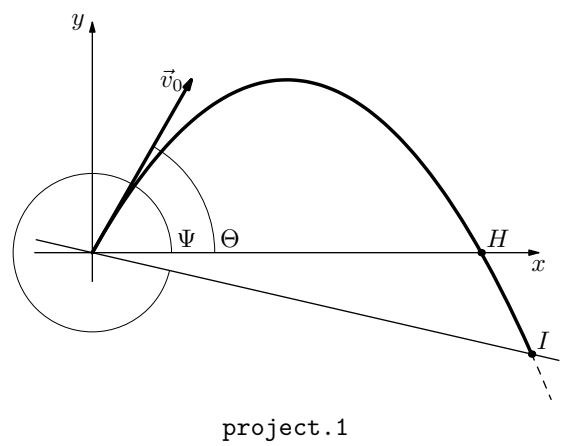
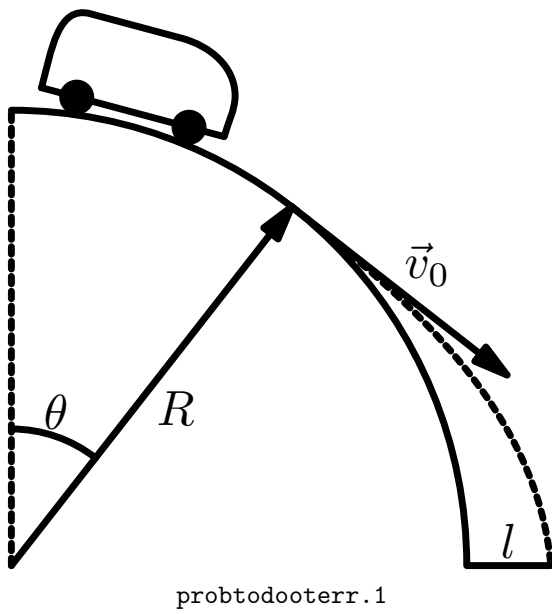
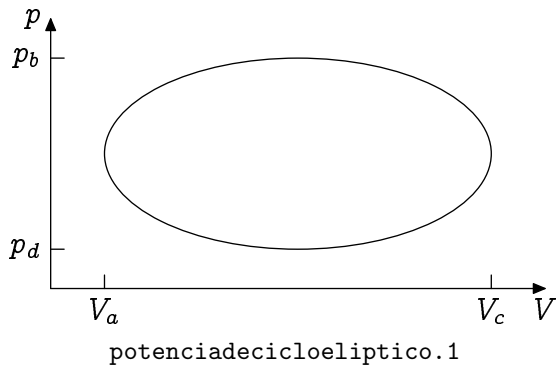



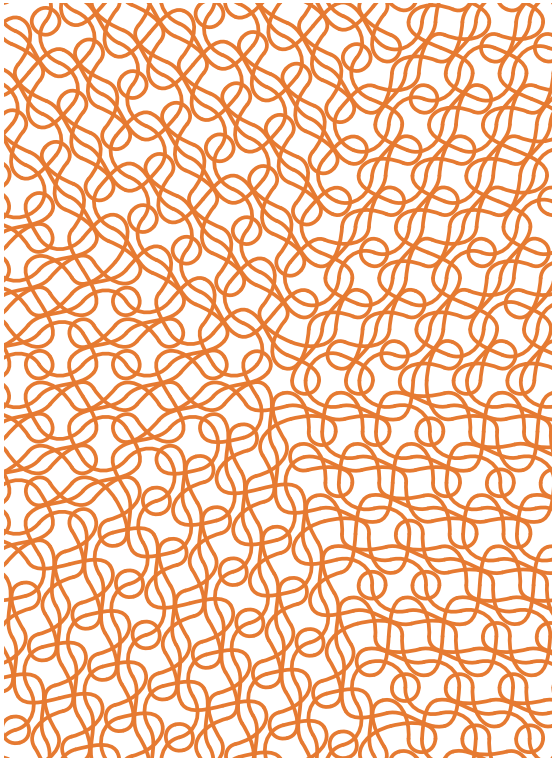

qap.1

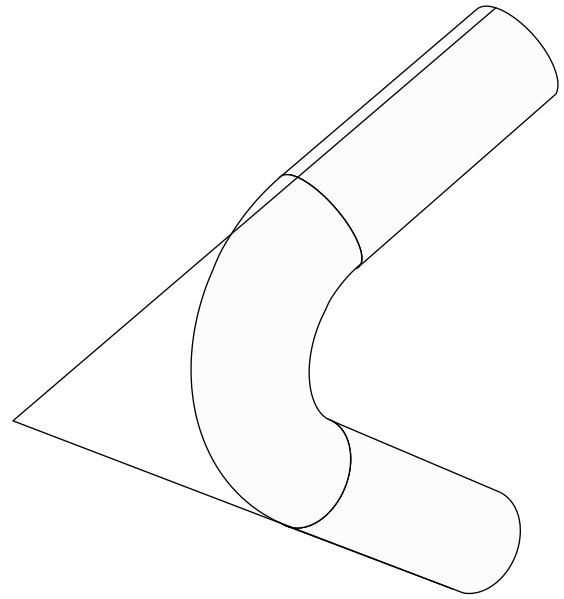

quartermorus.2

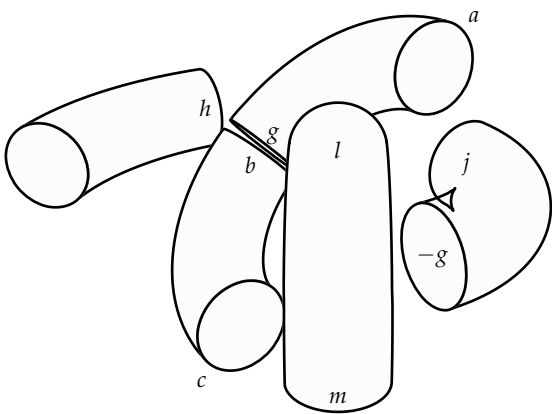

quartermorus.1

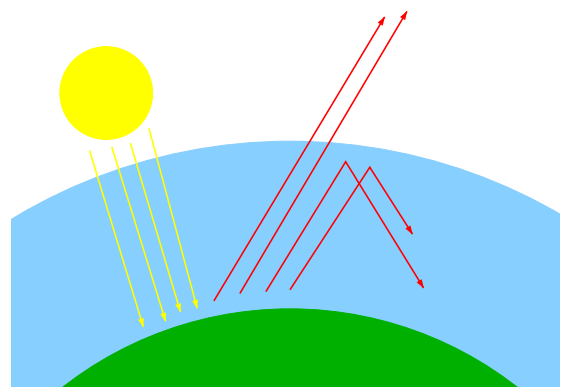

radiativeforcing.0

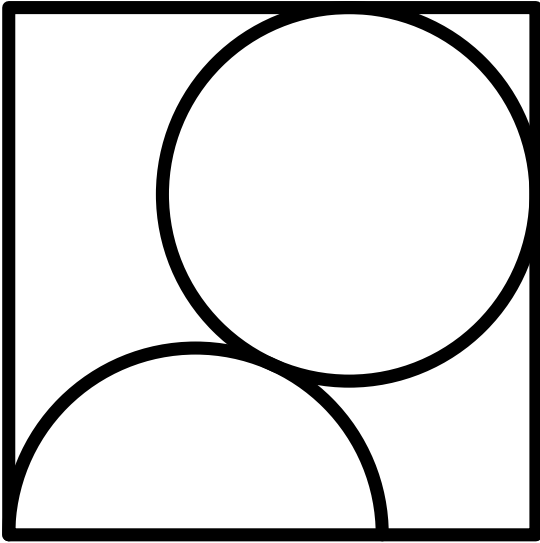

raiodoscircuitos.1

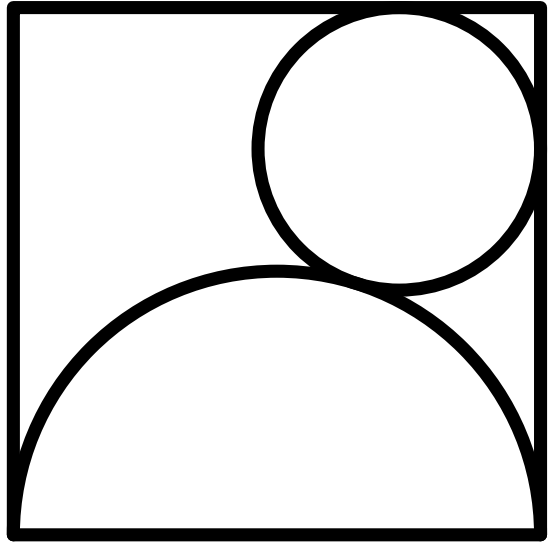

raiodoscircuitos.3

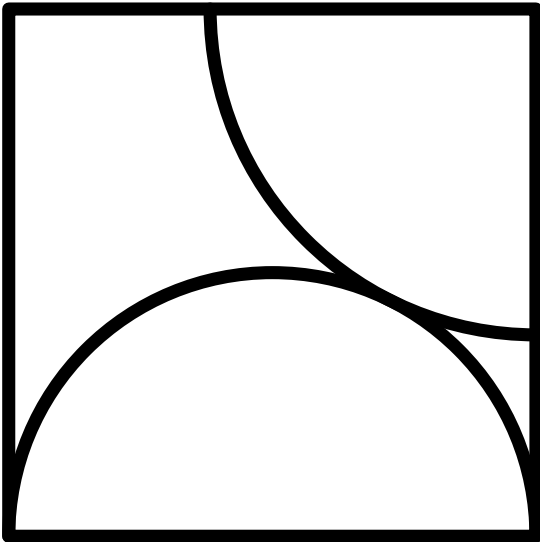

raiodoscircuitos.2

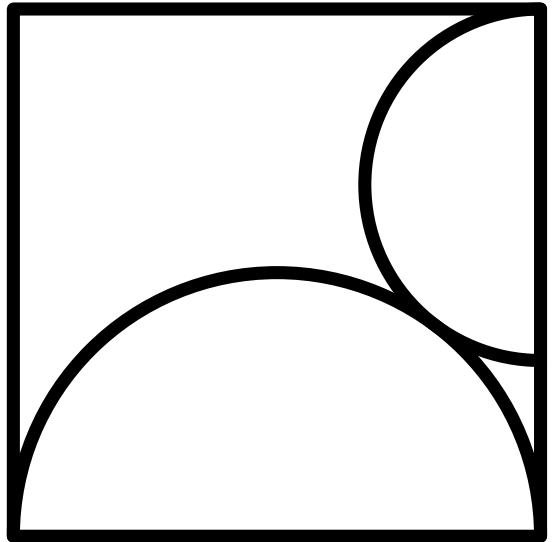

raiodoscircuitos.4

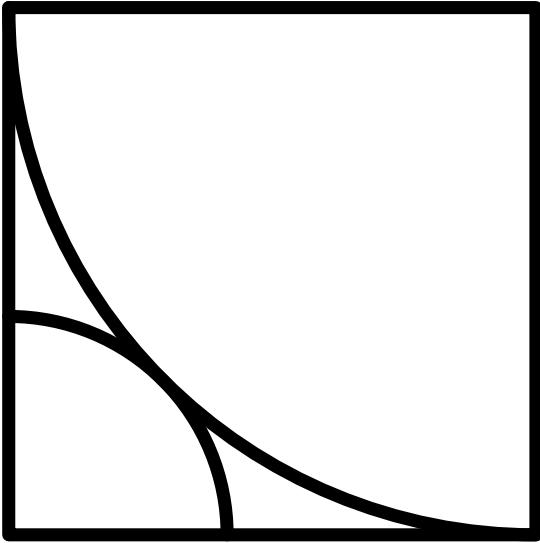

raiodoscirculos.5

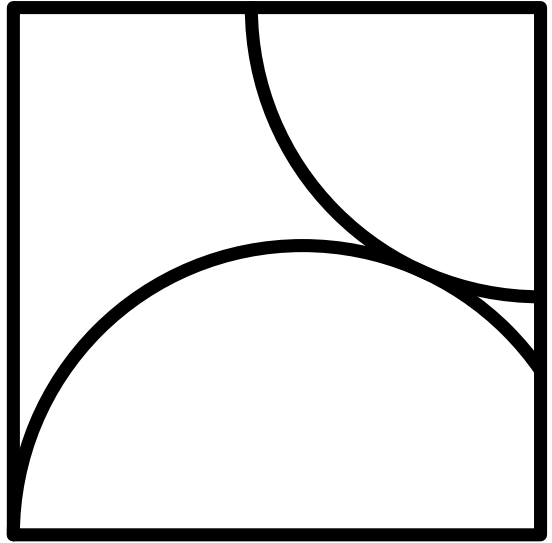

raiodoscirculos.7

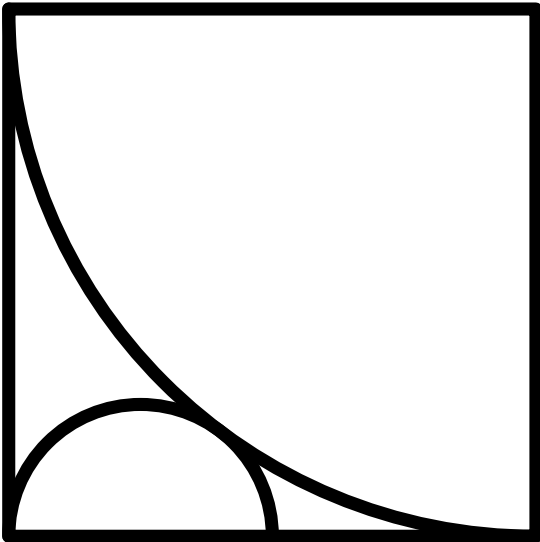

raiodoscirculos.6

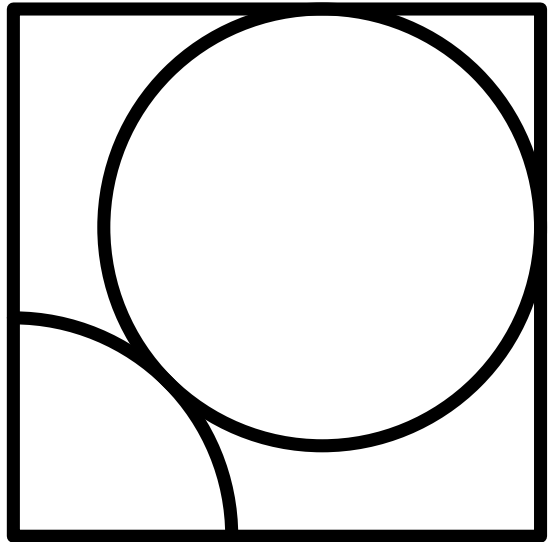

raiodoscirculos.8

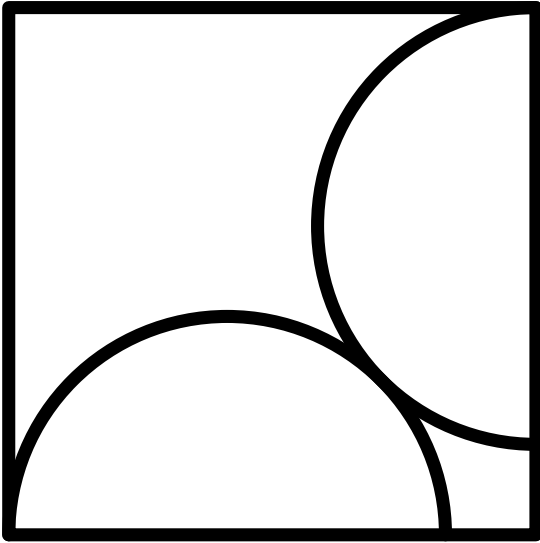

raiodoscircuitos.9



reeditedgoodquestionmark.1

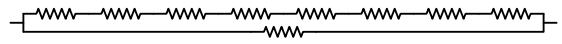

resistcircuit.1



redplanet.1

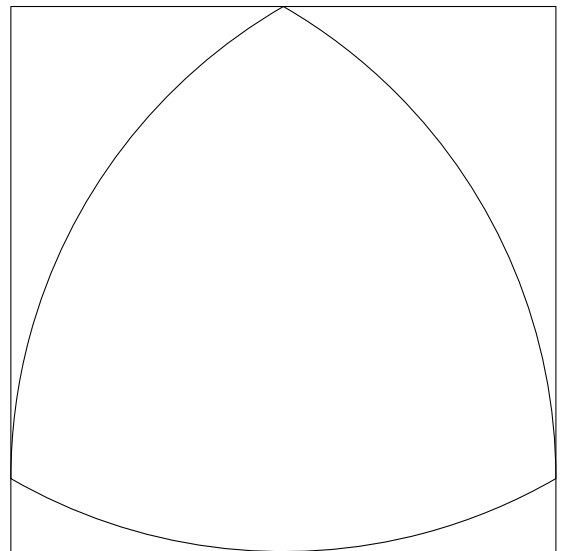

reuleaux.1

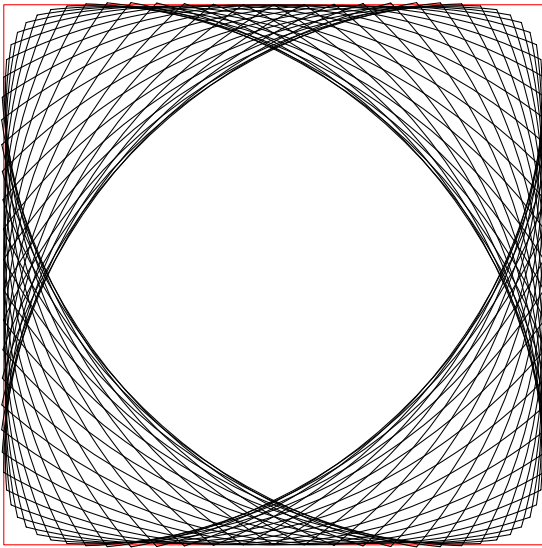

reuleaux.2

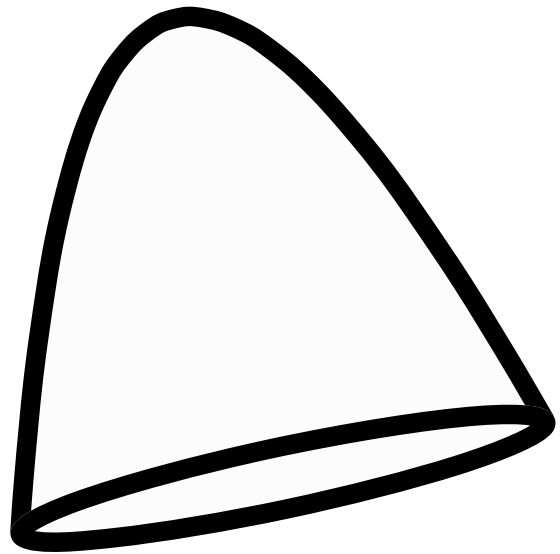

revolutionparaboloid.1

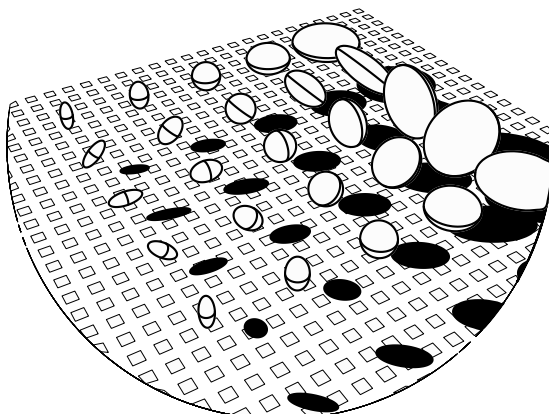

revolipsoid.1

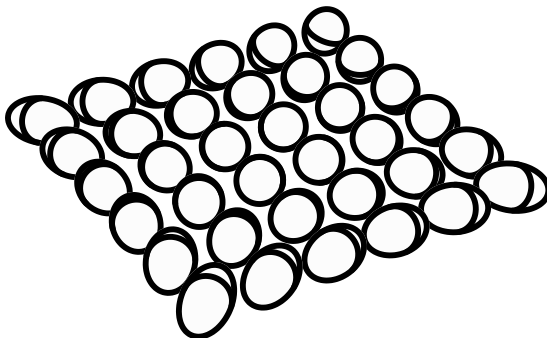

revolipsoid.2

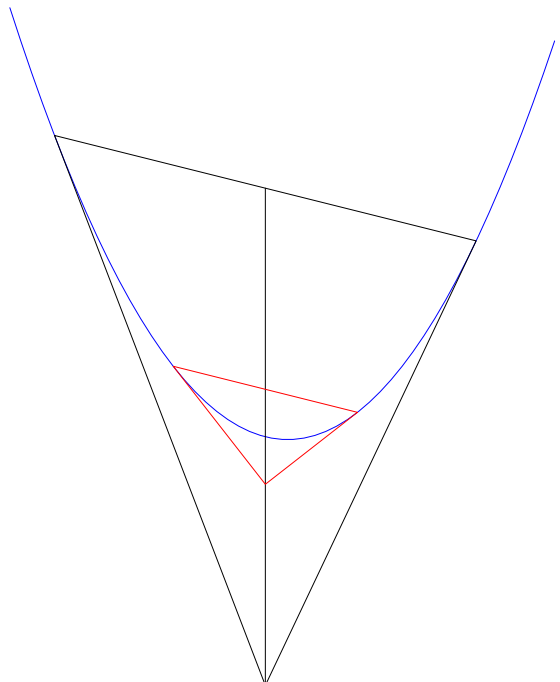

revolutionparaboloid.2

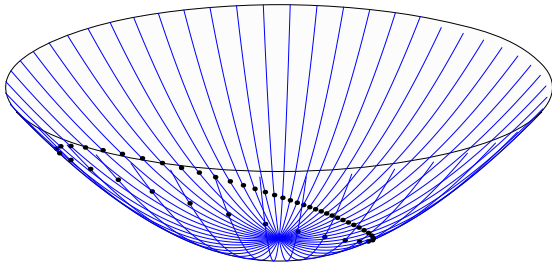

revolutionparaboloid.3

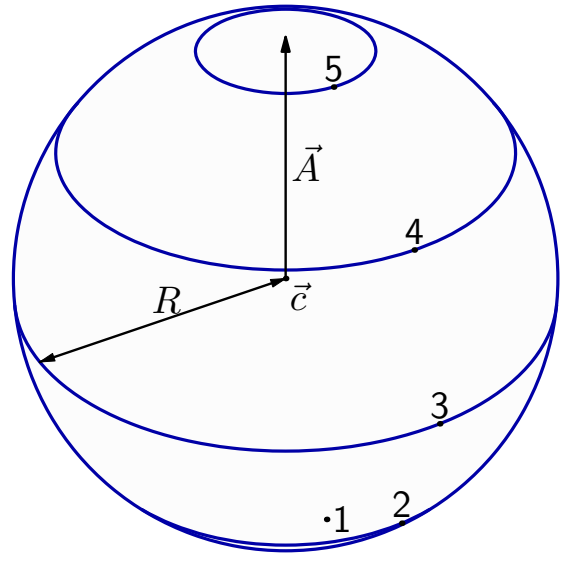

revolvers.1

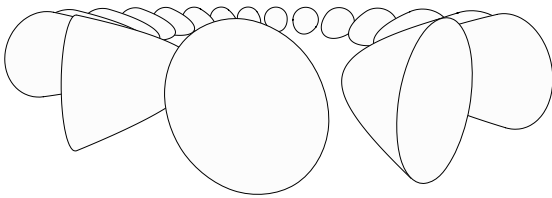

revolutionparaboloid.4

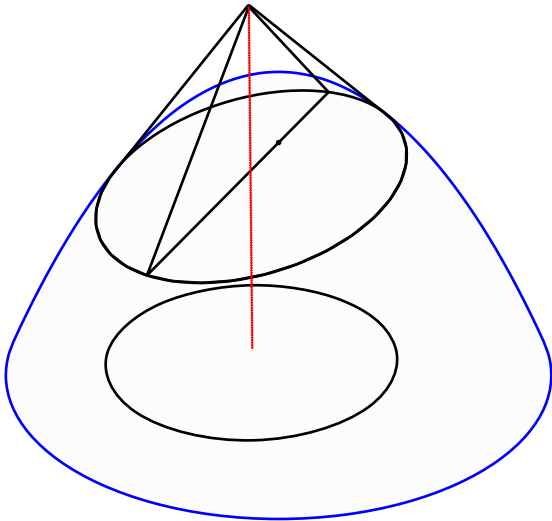

revolutionparaboloid.5

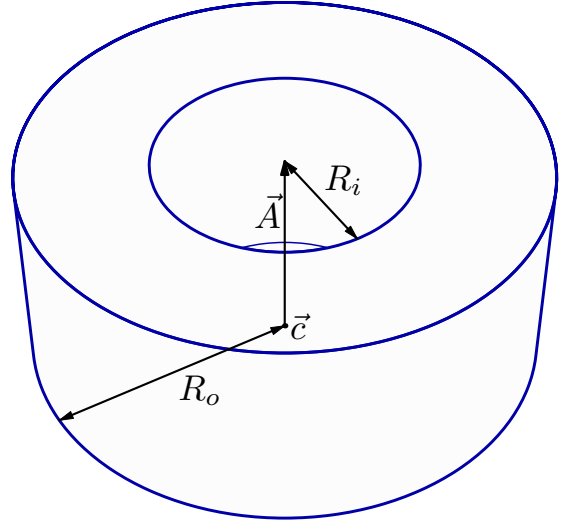

revolvers.2

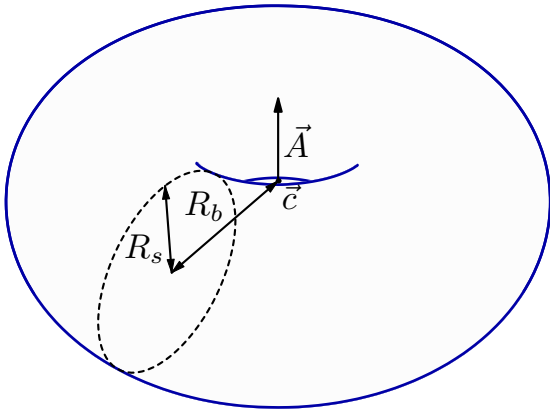

revolvers.3

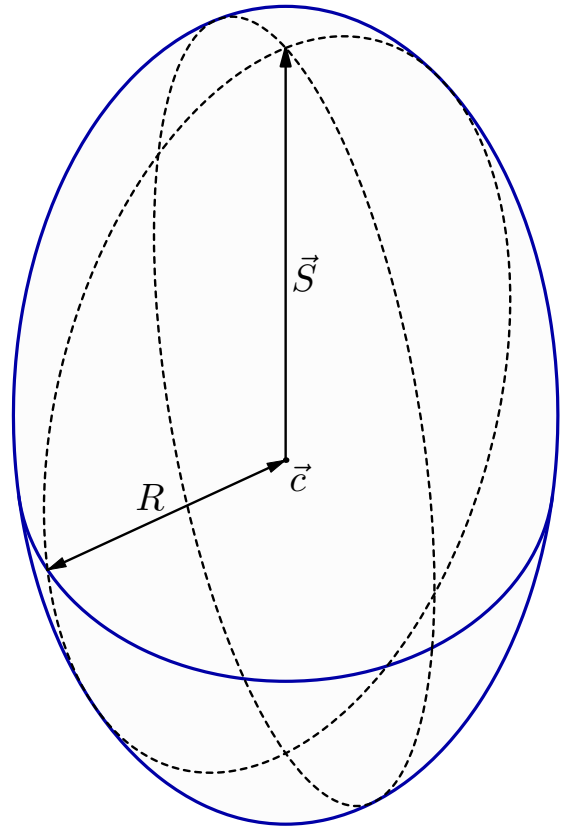

revolvers.5

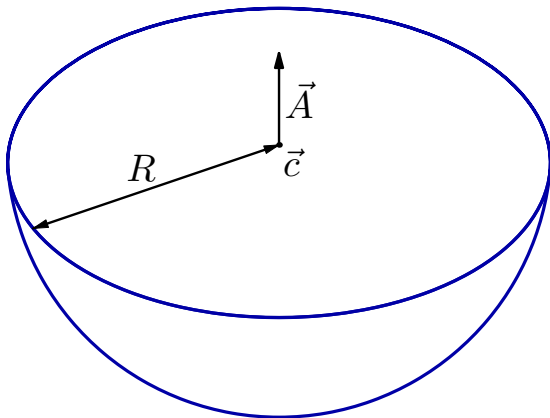

revolvers.4

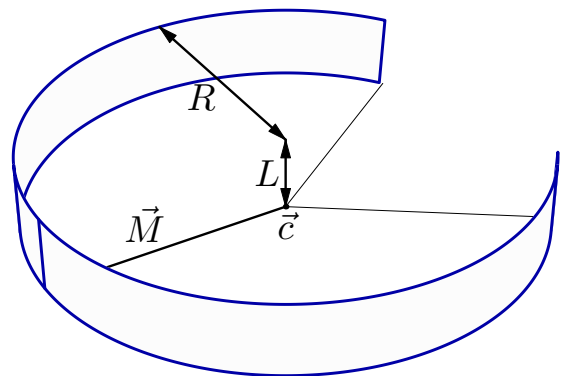

revolvers.6

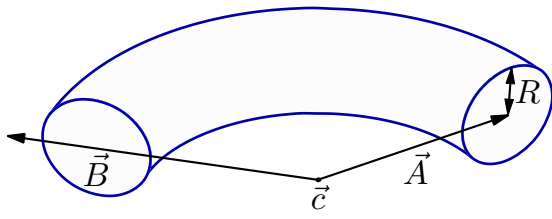

revolvers.7

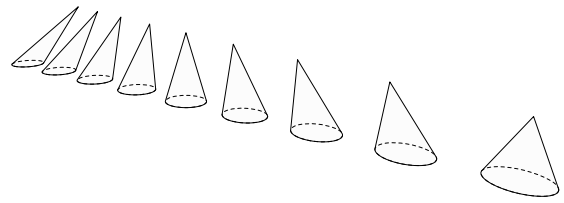

rigorouscone.1

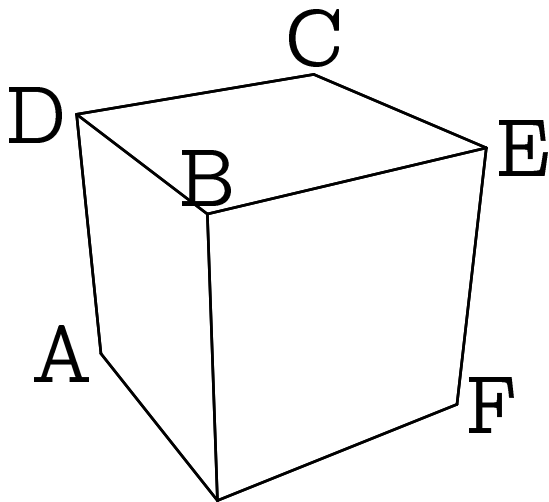

rigorcubo.0

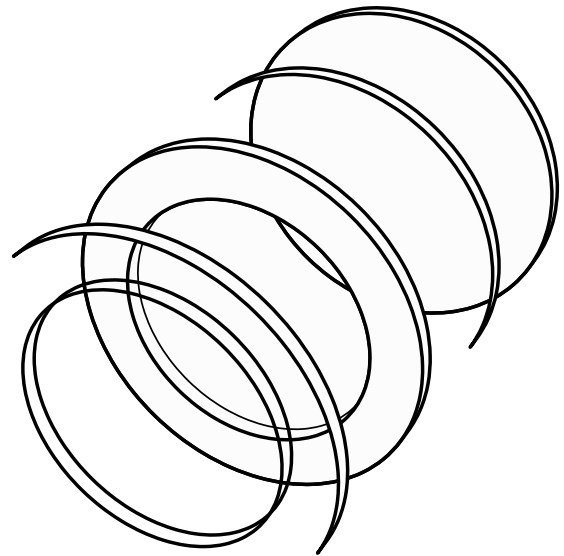

rigorousdiscptions.1

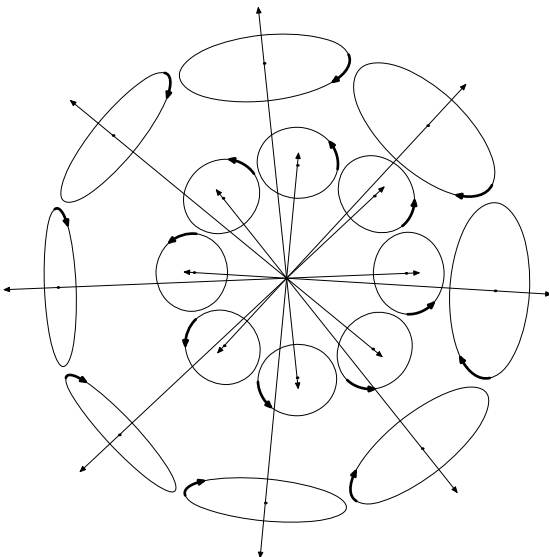

rigorouscircle.1

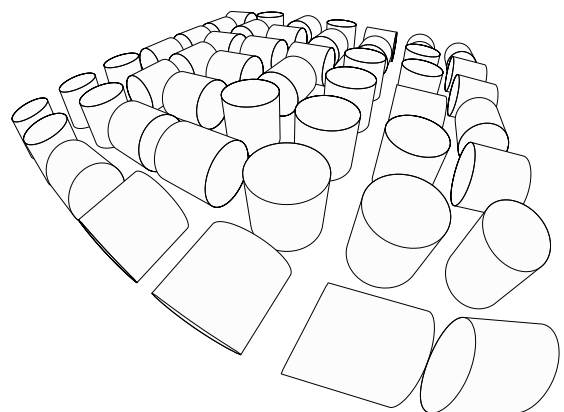

rigorousdiscSD.1



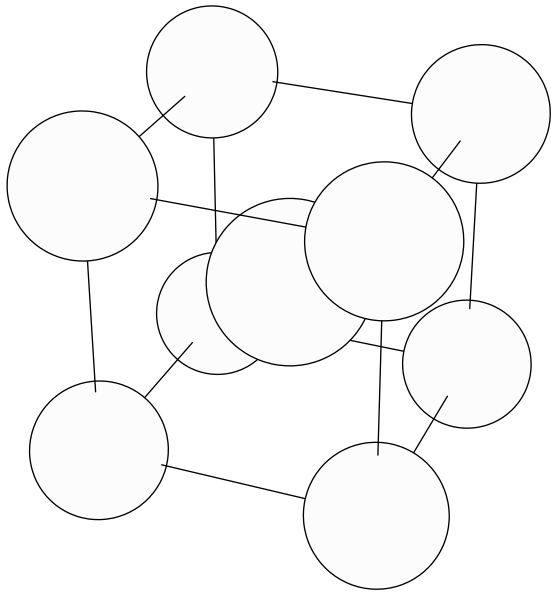

rigorousfearpath.1



roadincline.1

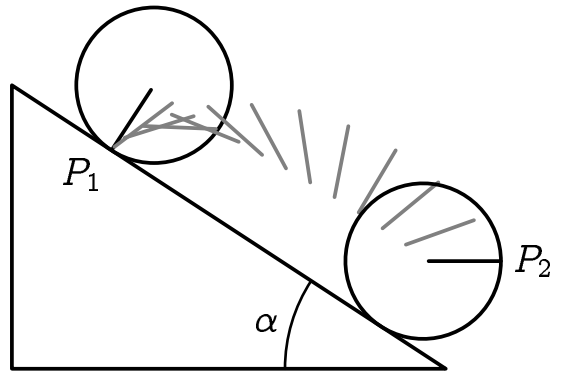

rodarolaremplanc.1

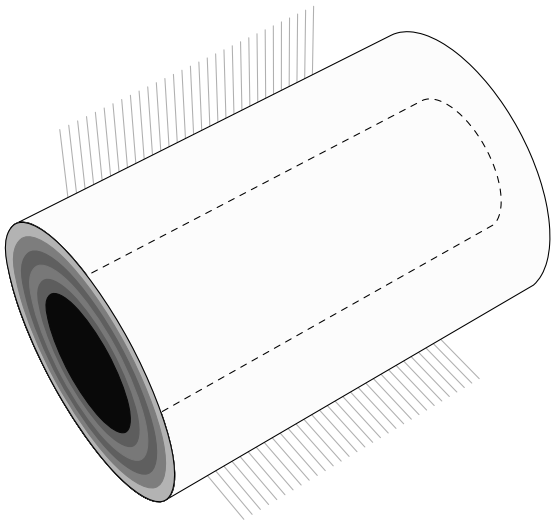

rmnbob.1

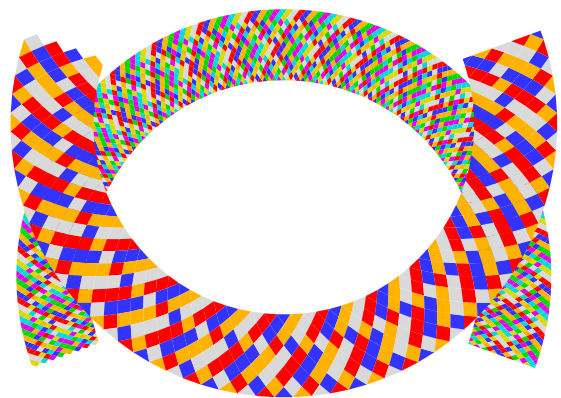

ropepatterns.1

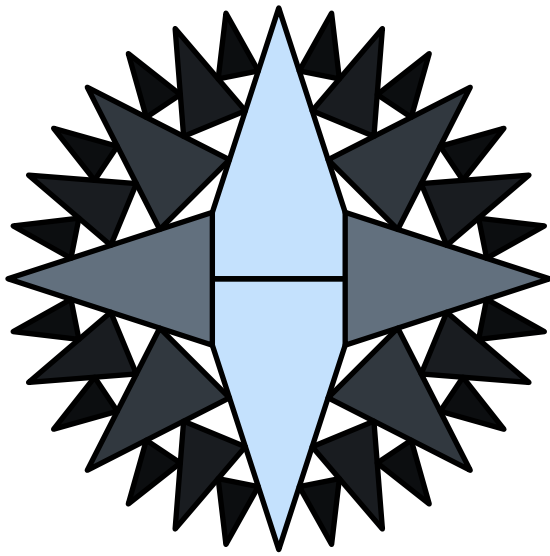

rosadosventos.1

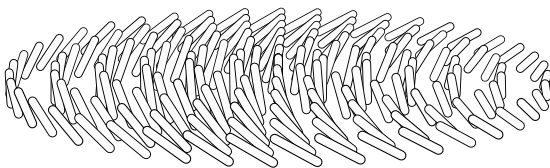

rotatnlc.1

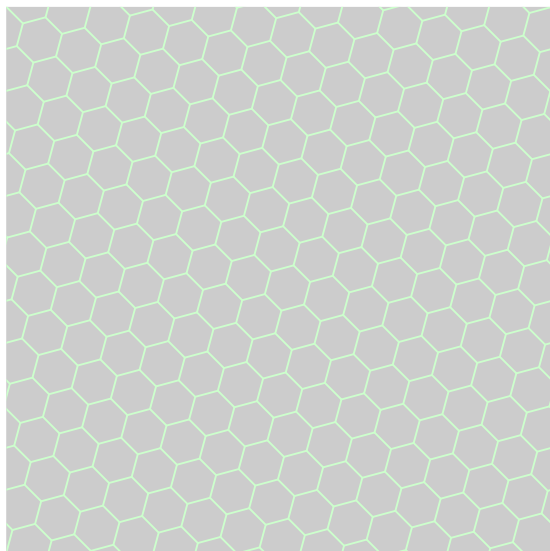

rothexagrid.1

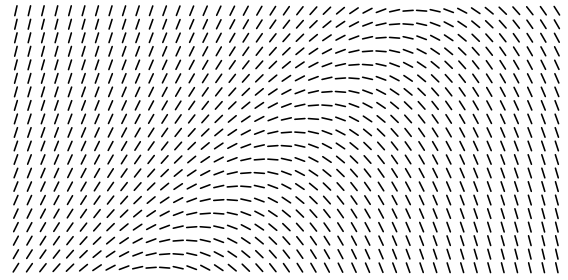

rungekuttasecond.1

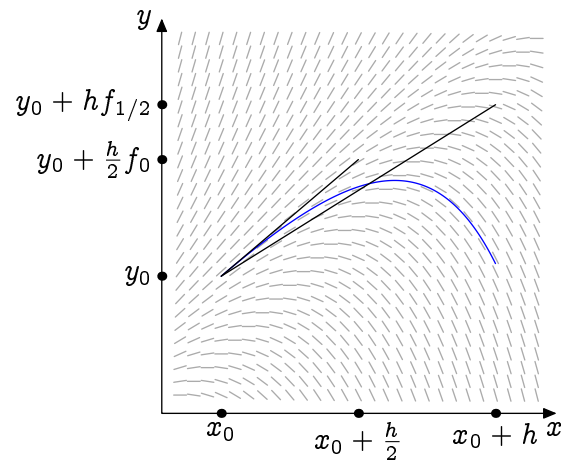

rungekuttasecond.2

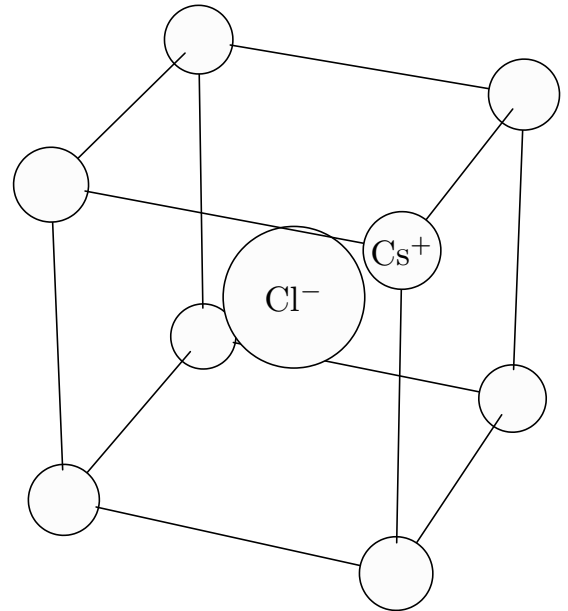

sal.1

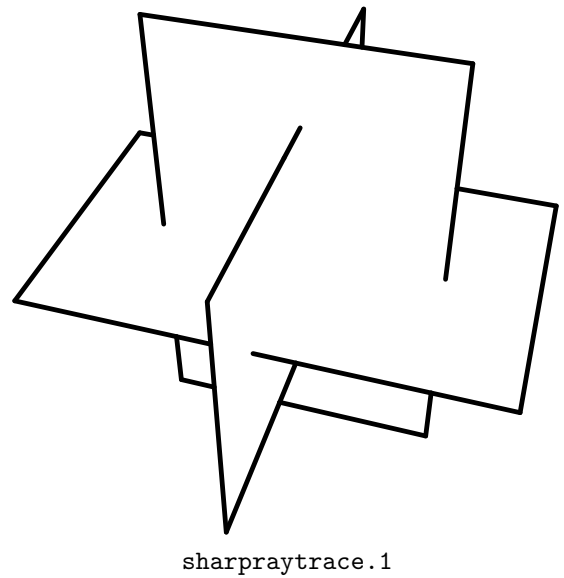
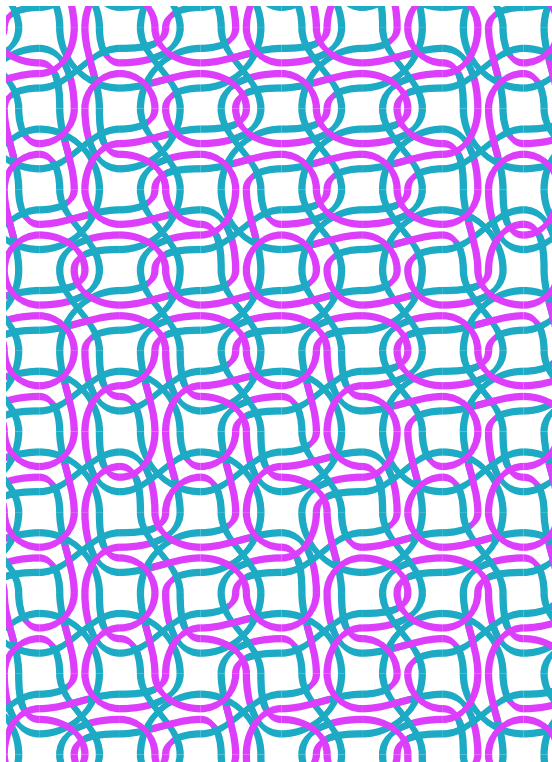
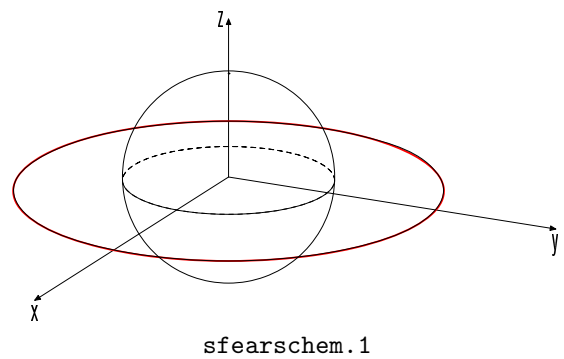
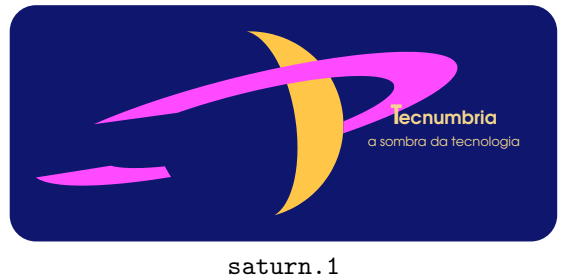
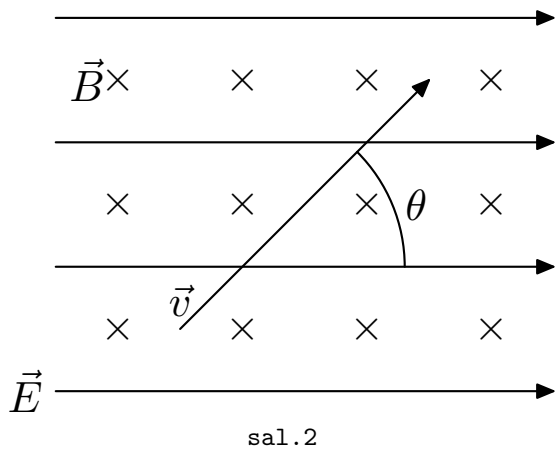

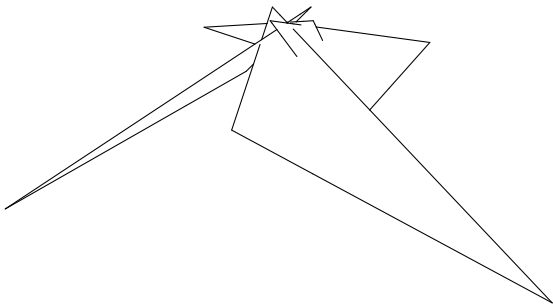

sharpraytrace.2

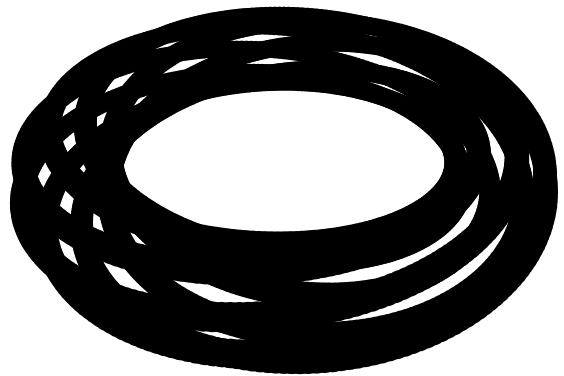

signalvertexSD.1

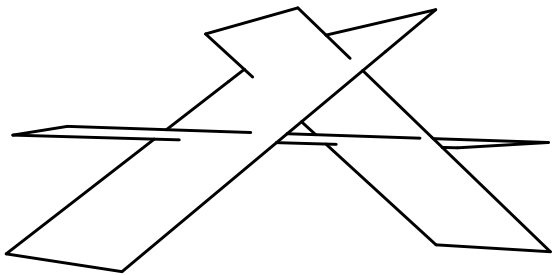

sharpraytrace.3

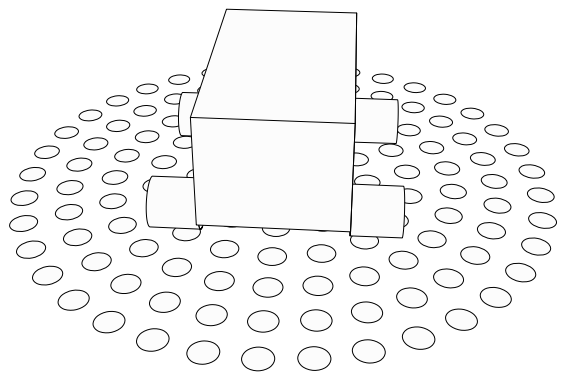

simplecar.1

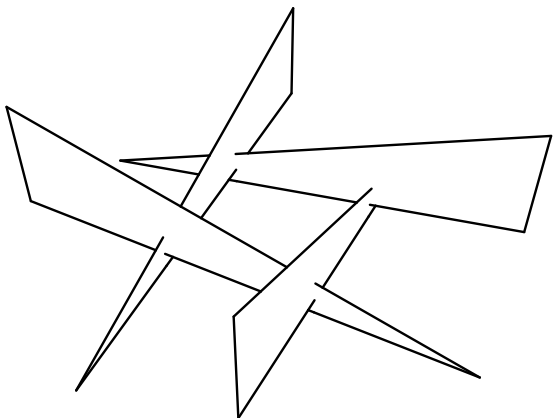

sharpraytrace.4

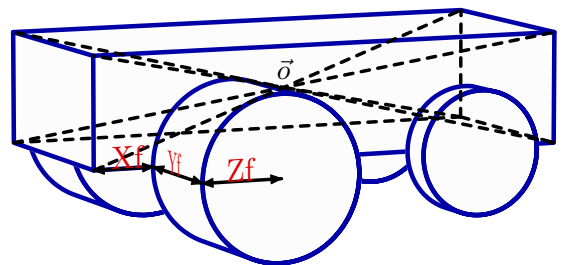

simplecarparam.1

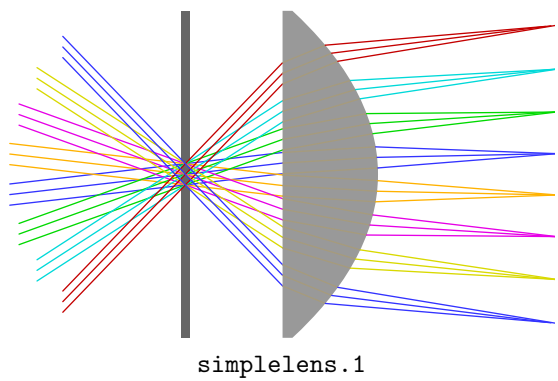
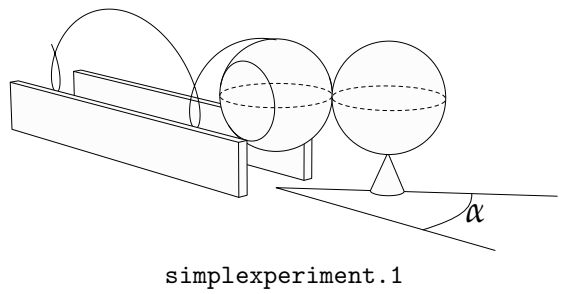
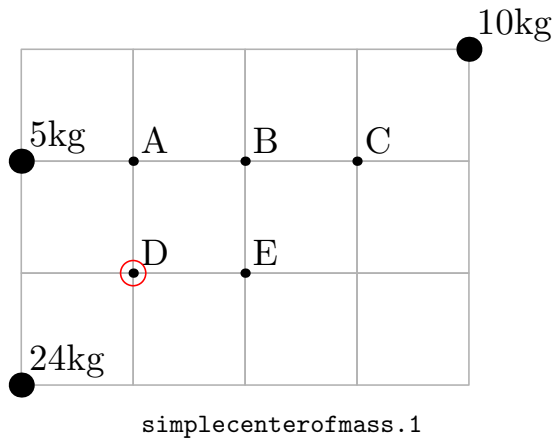
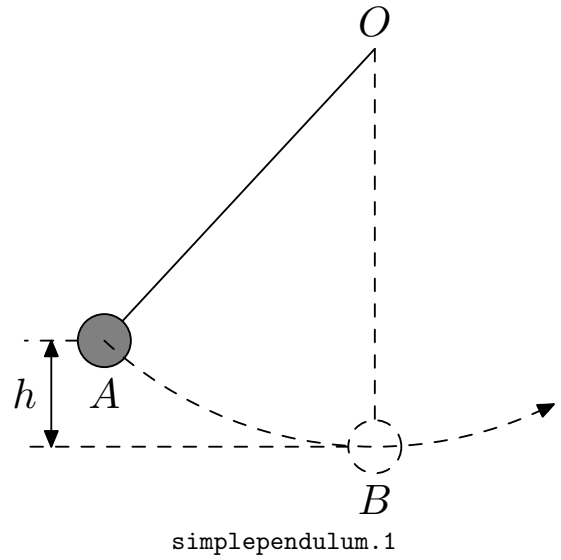
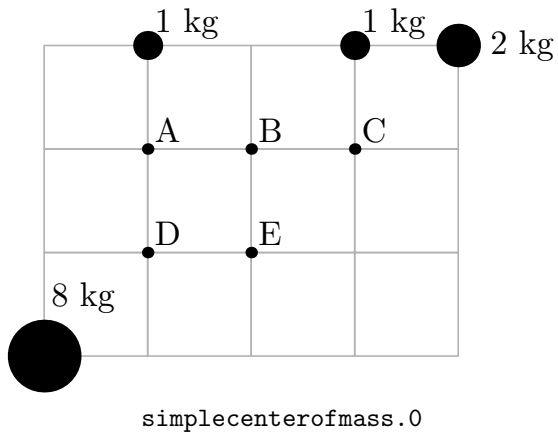

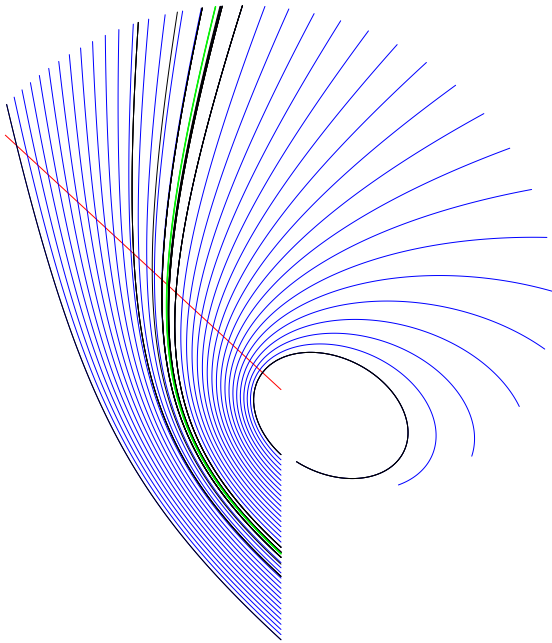

slingshot.1

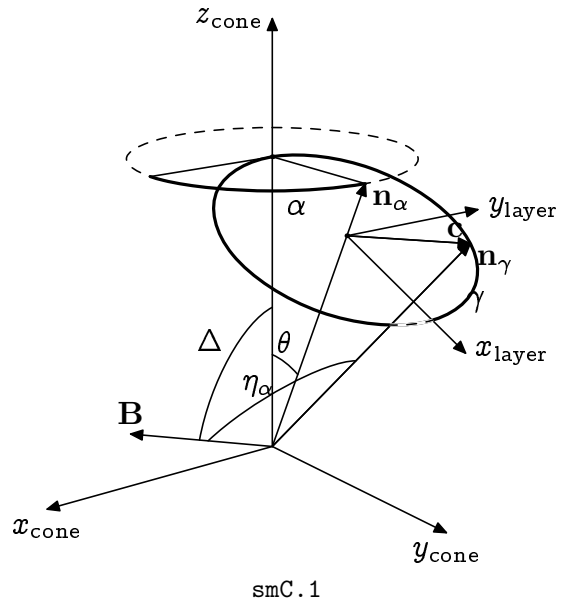

smC.1



SlowDownNowBitmapScanned.1

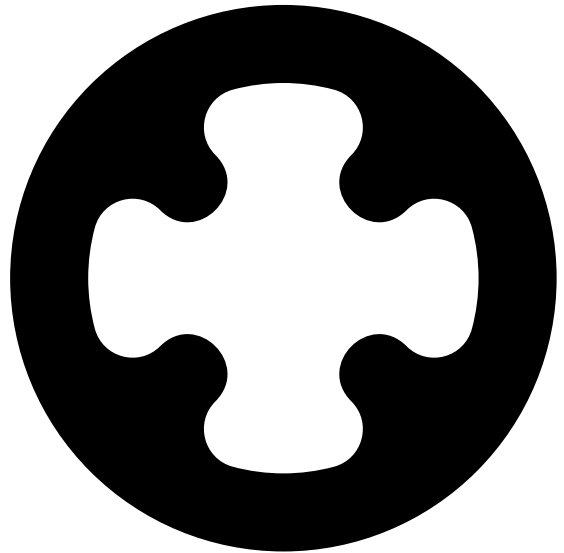

sniperlogo.1

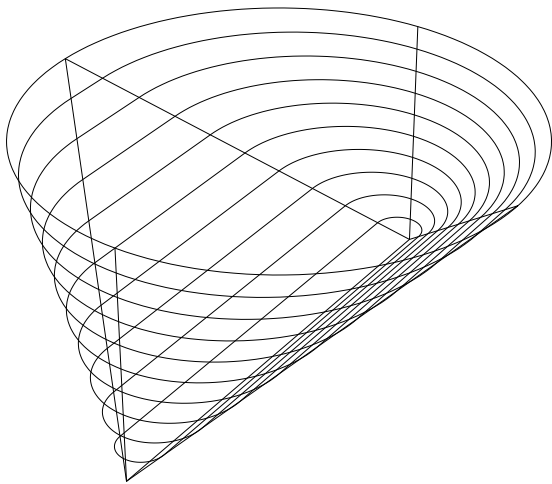

solarconcentrator.1

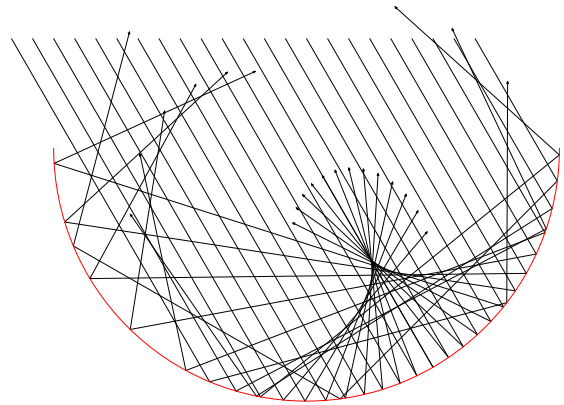

solar dish.3

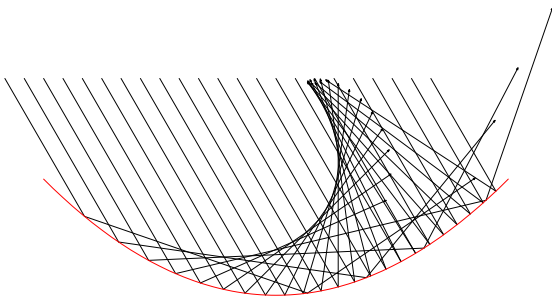

solar dish.1

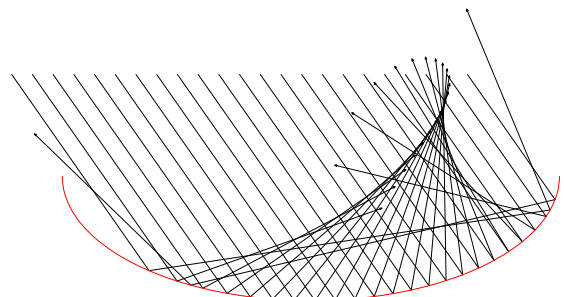

solar dish.4

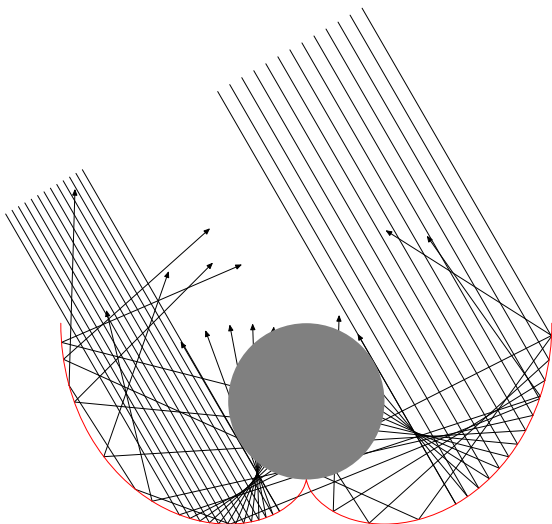

solar dish.2

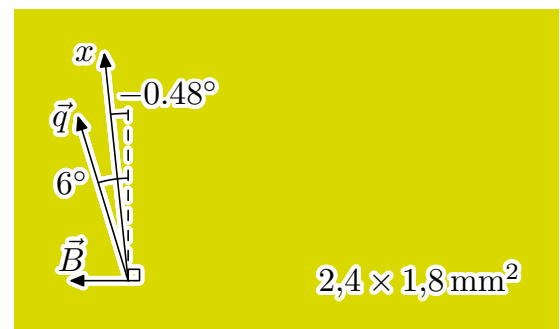

some2Dvecs.1

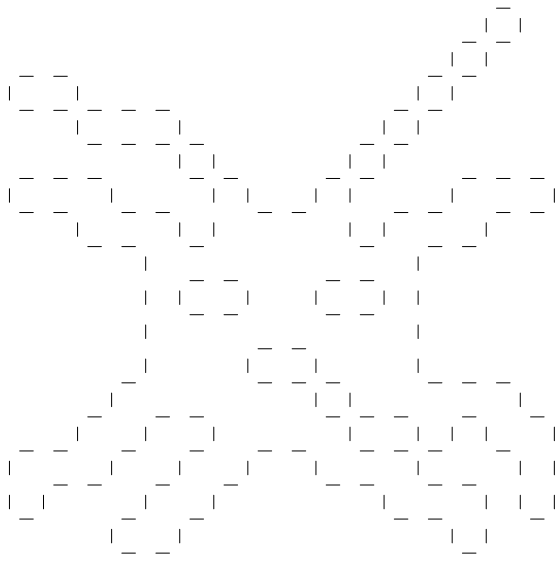

spaceinvader.1

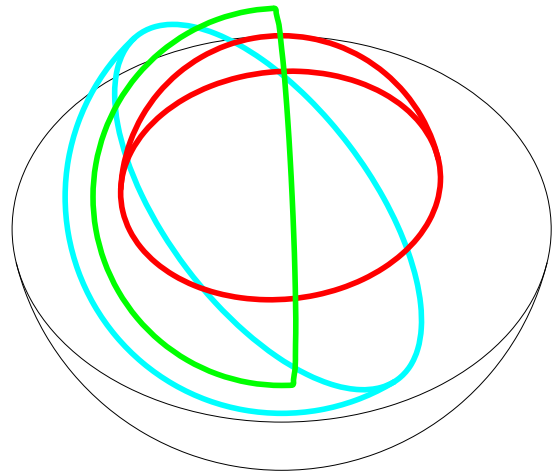

spatialhalfsfear.1

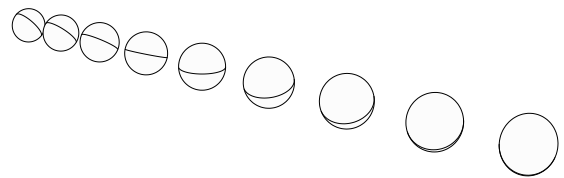

spherample.1



spaceinvader.2

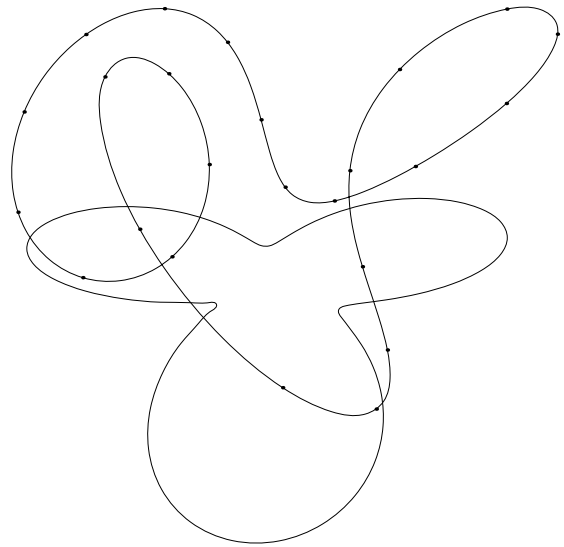

splineperspective.0



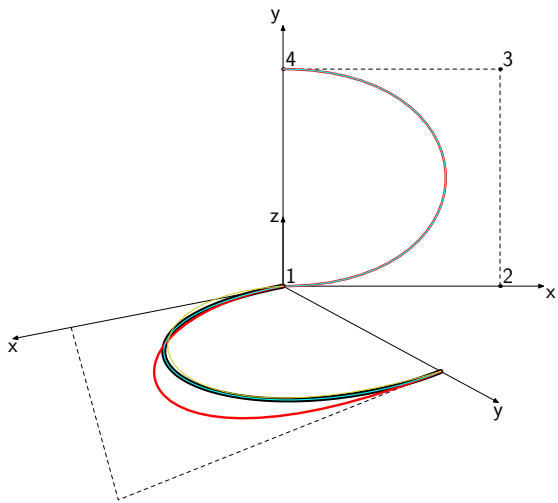

splineperspective.1

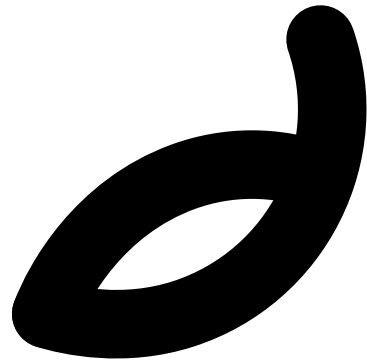

splineperspective.3

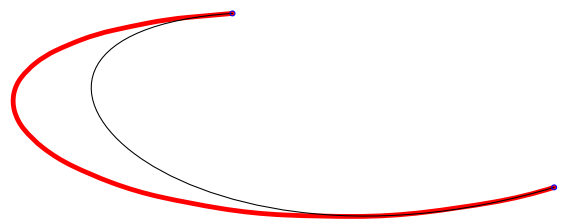

splineperspective.4

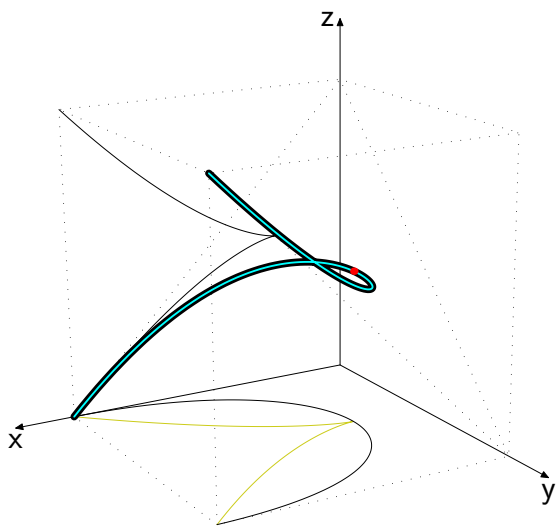

splineperspective.2

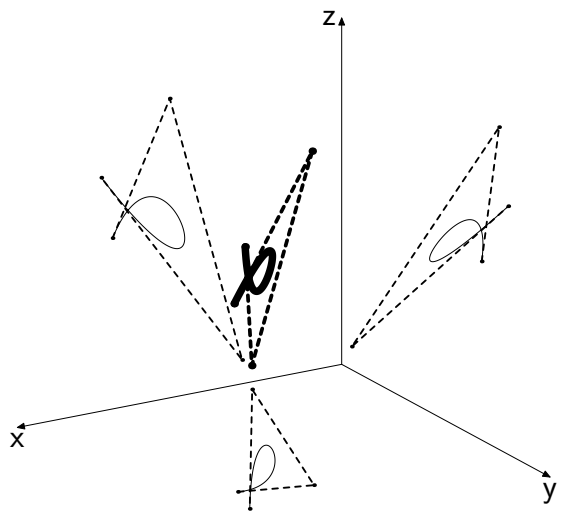

splineperspective.5

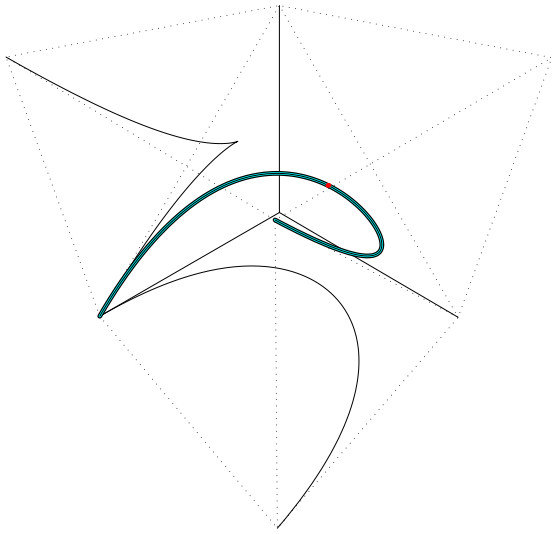

splineperspectives.1

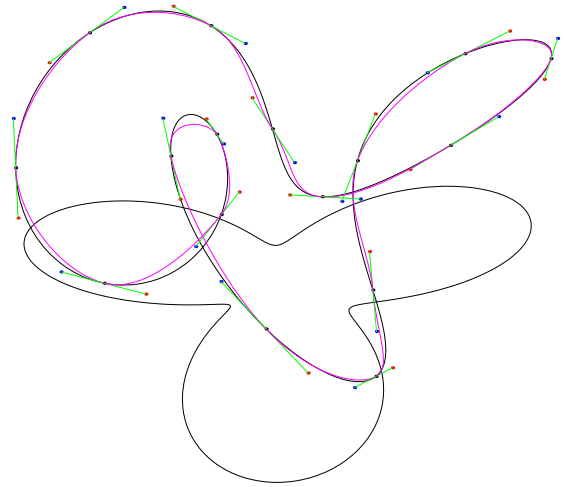

splineperspectives.3

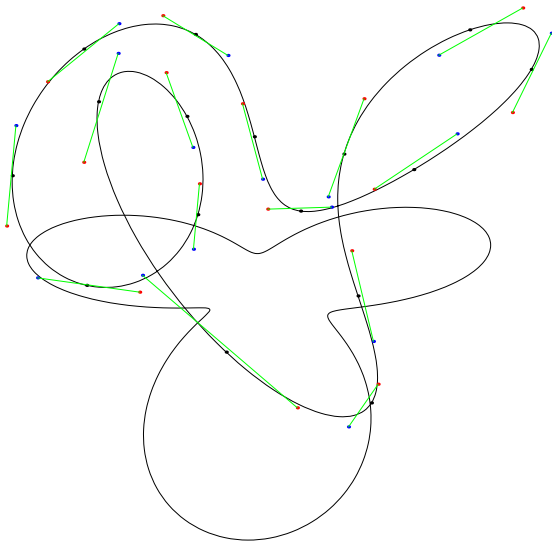

splineperspectives.2

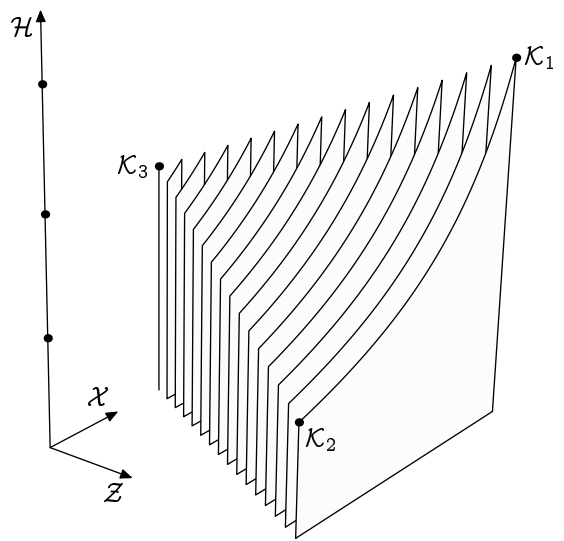

spltwiben.1

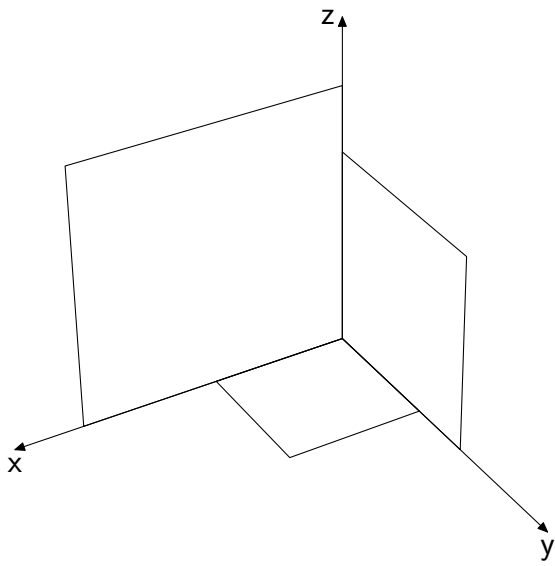

squareanglines.1

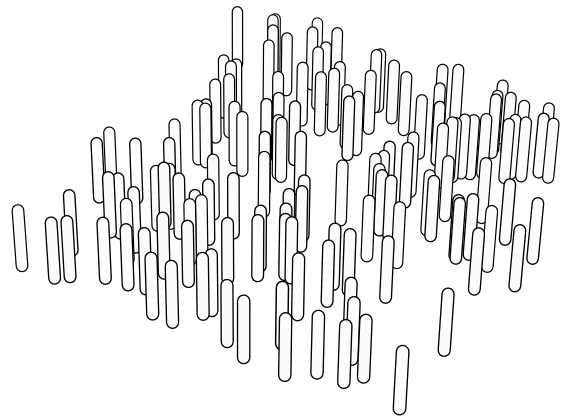

srinathpolineni.3

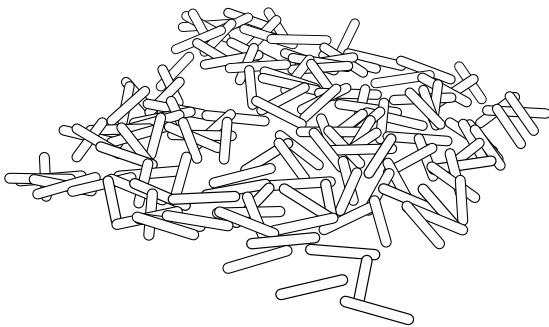

srinathpolineni.1

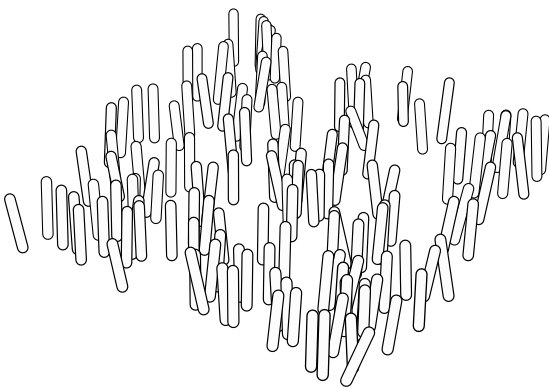

srinathpolineni.2

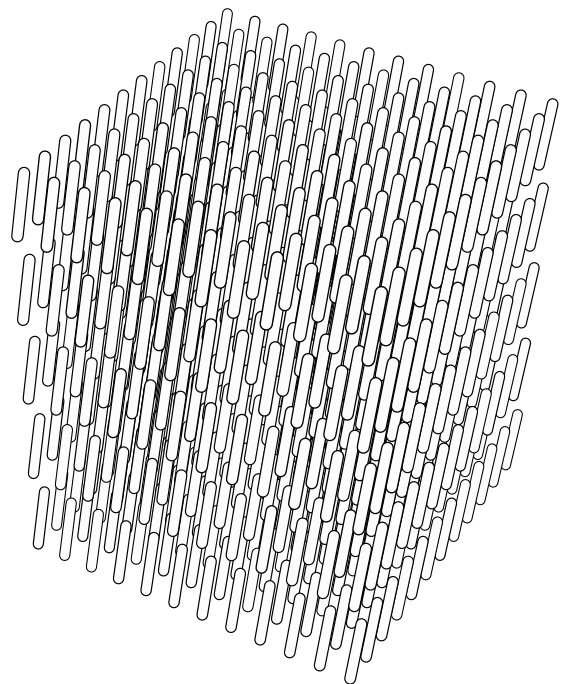

srinathpolineni.5

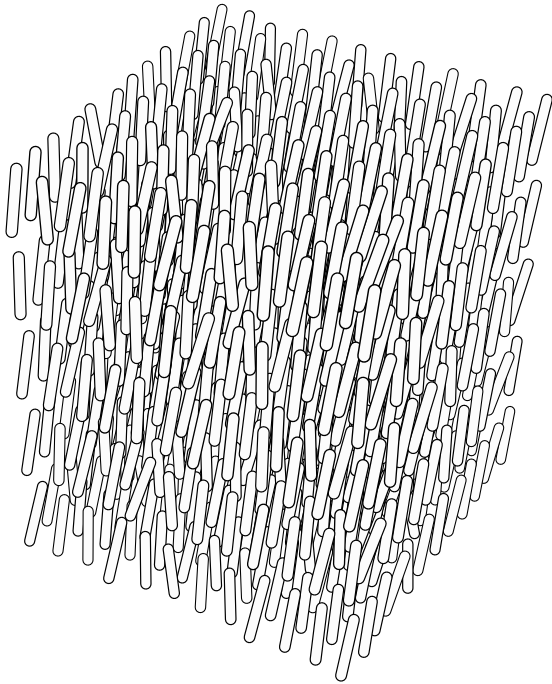

srinathpolineni.6

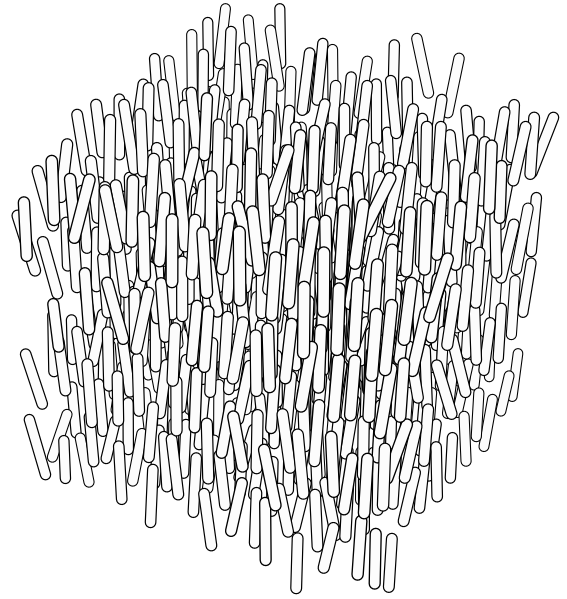

srinathpolineni.8

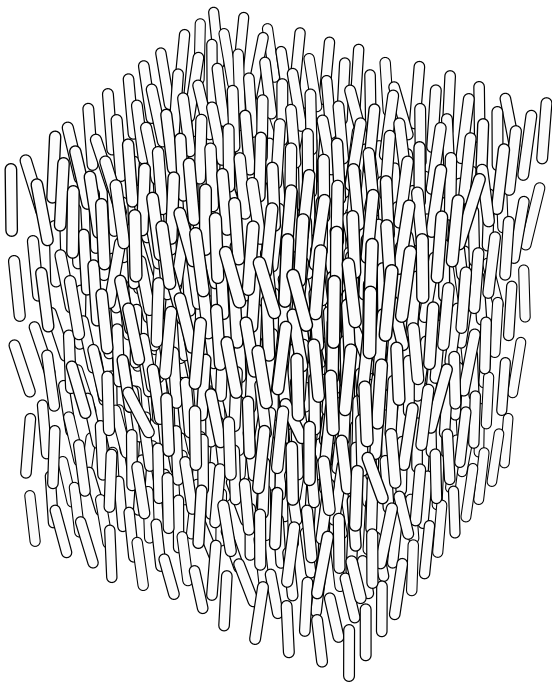

srinathpolineni.7

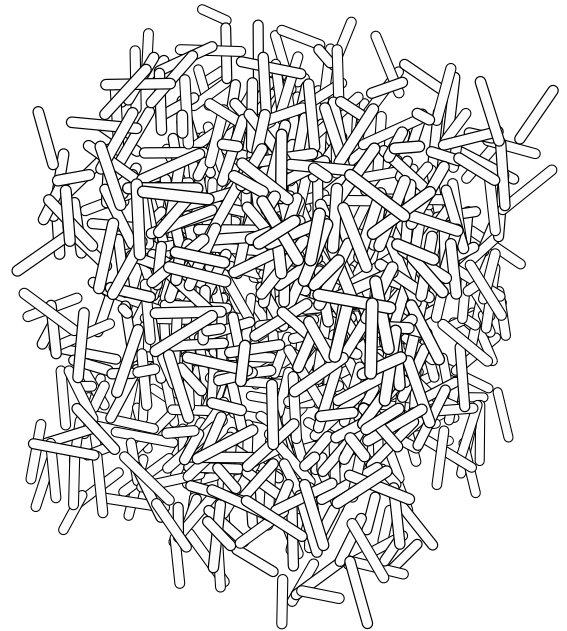

srinathpolineni.9

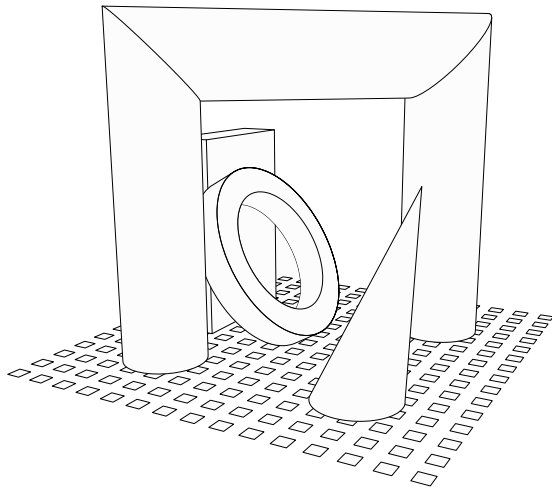

stageforthree.1

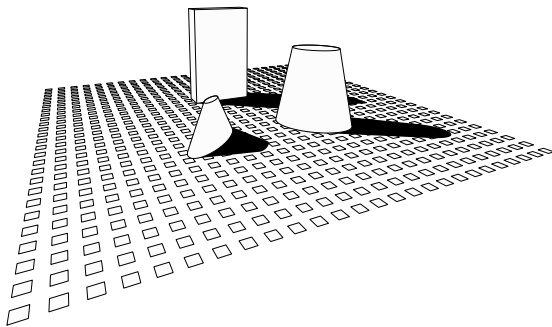

stageforthree.2

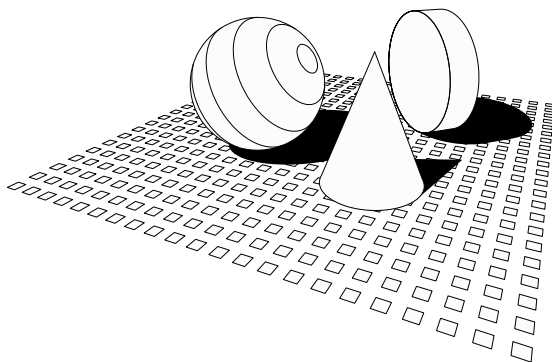

stageforthree.3

GETT'N'READY

4D

C-L-I-M-B

statement.1

one life

40

DRILLS

statement.2

*Eu Vivo  
na  
Cauda da Europa*

statethreelines.0

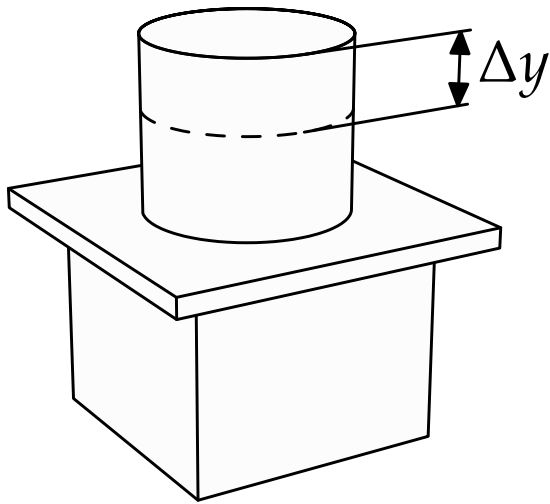

steamcamera.0

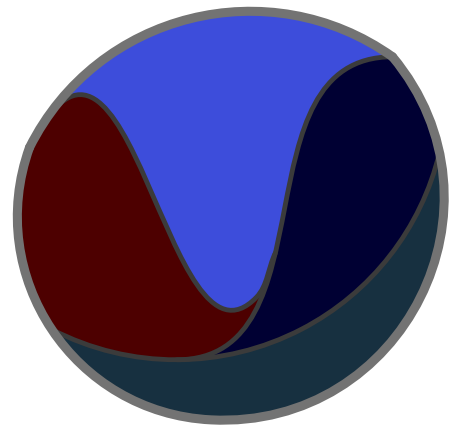

**GNUPLOT**  
WE SHARE OUR VISION

symbol.1

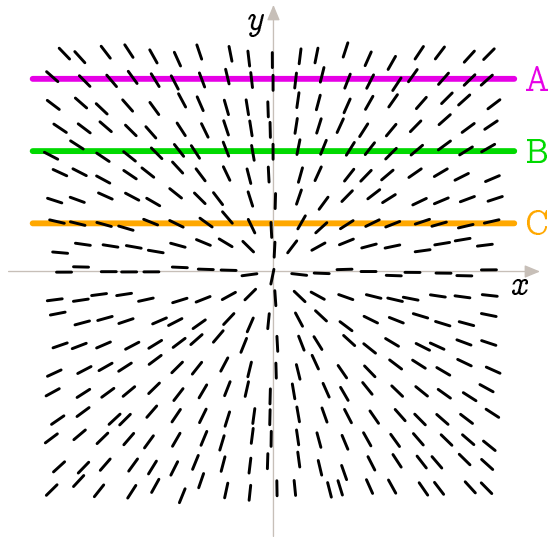

strength1defect.1

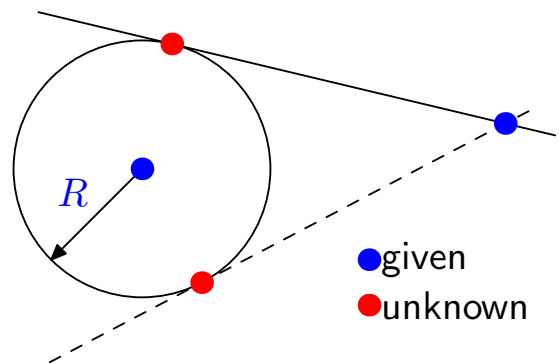

tangency2D.1

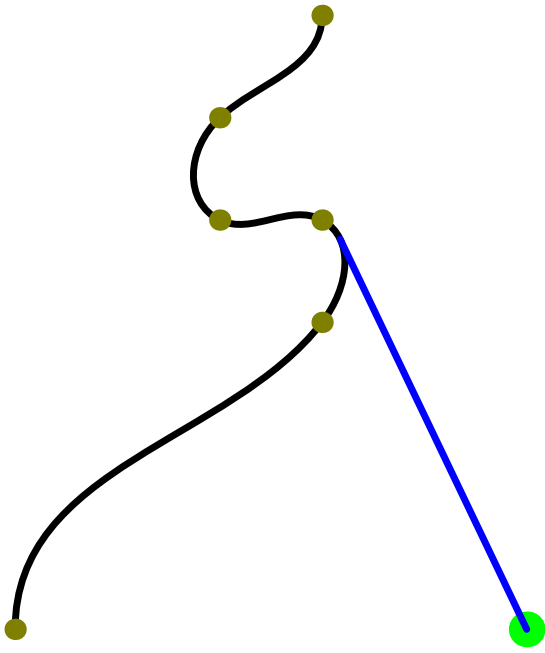

tangencypoint.1

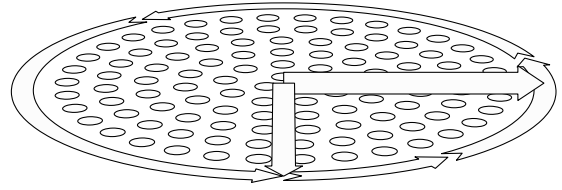

tdcircarrow.1

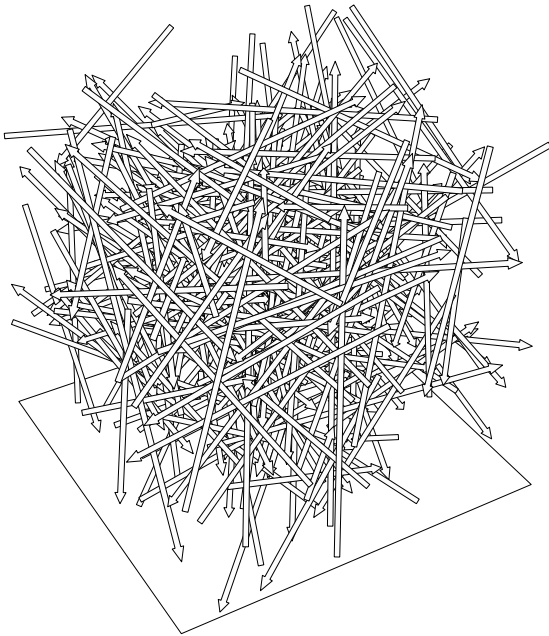

tdarrow.1

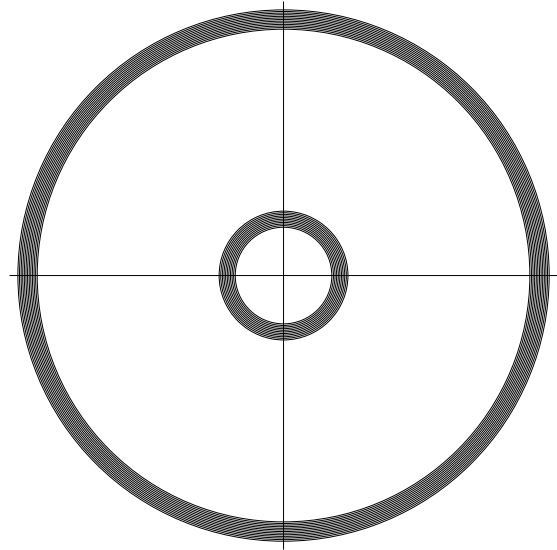

telemira.1

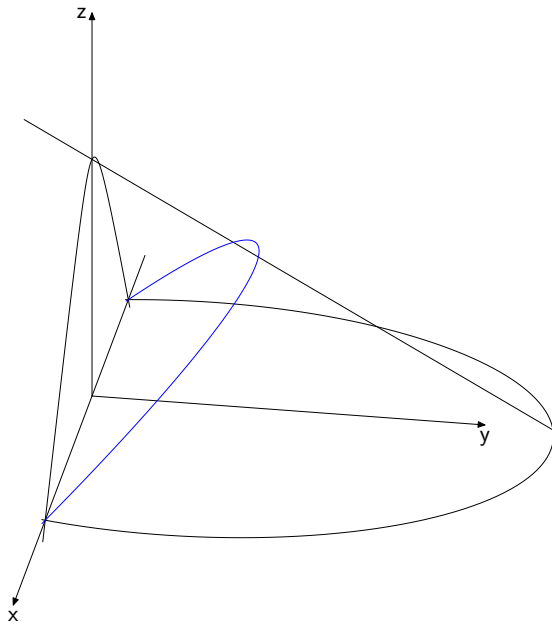

telheiro.1

# TEX & LATEX

tete.1

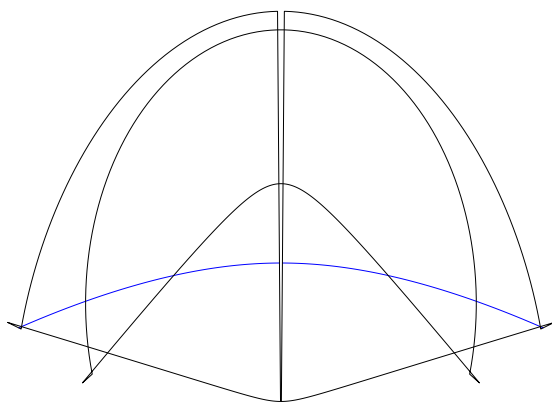

telheiro.2

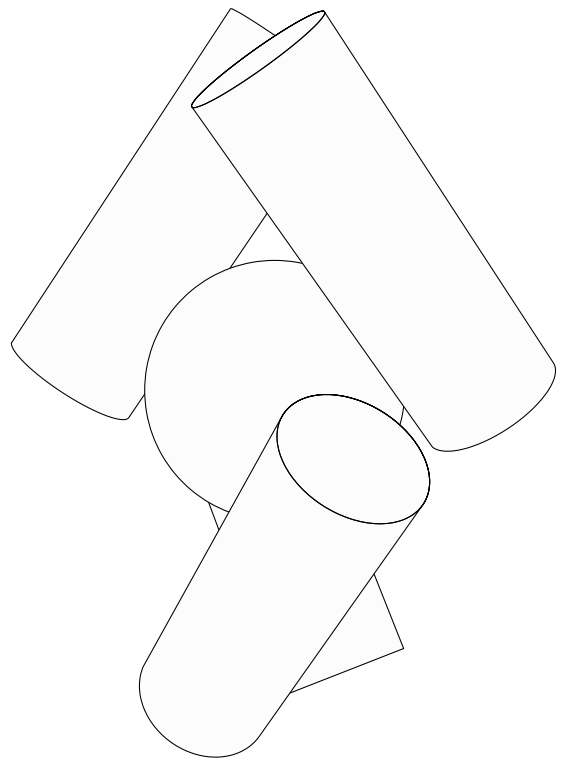

tetrapodes.1



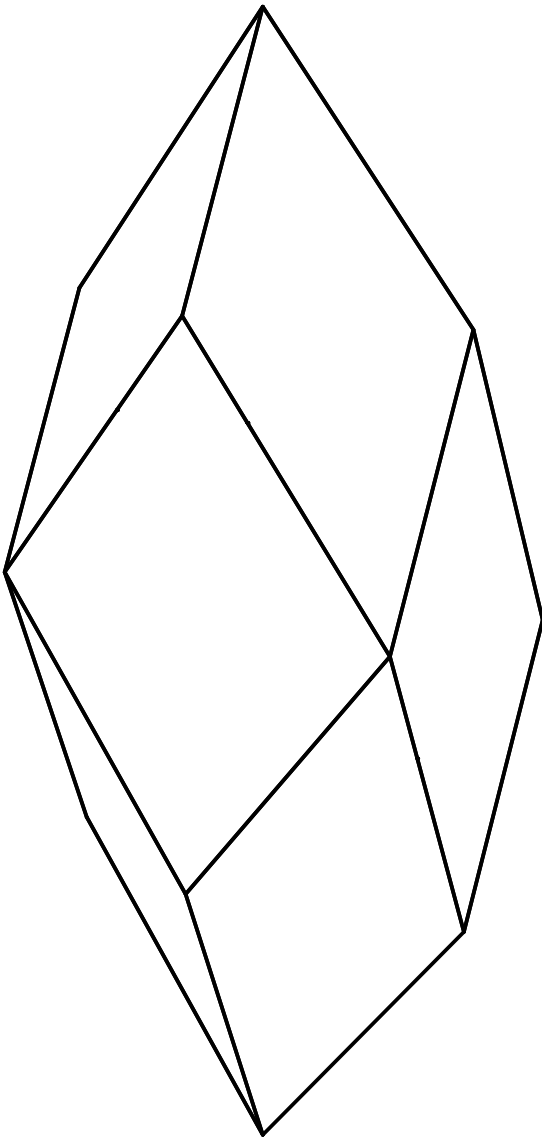

tetrapodes.2

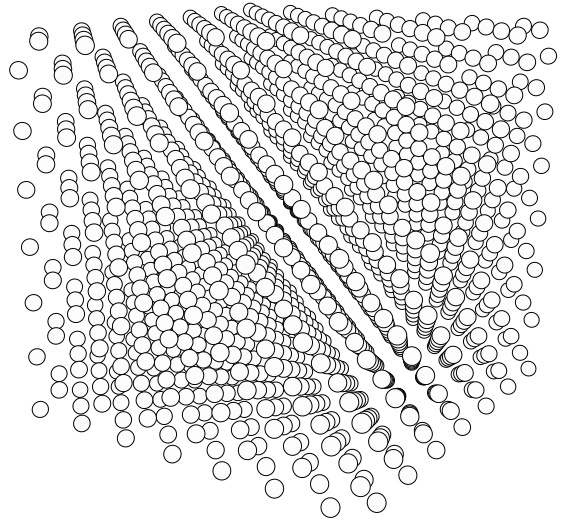

tetrapodes.3

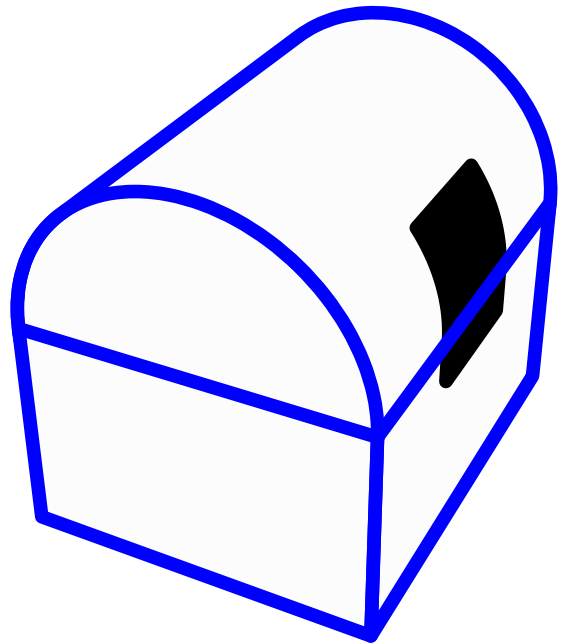

thearchicon.1

# HURD

theHURD.1

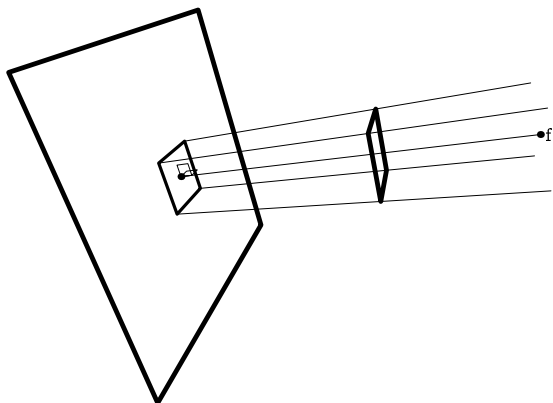

thethreekindsofperspec.1

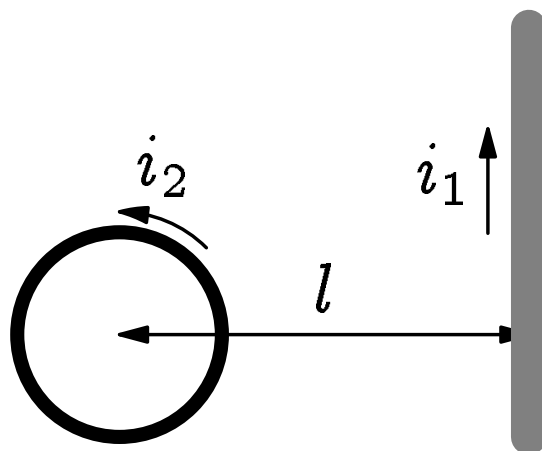

thunderproblem.1

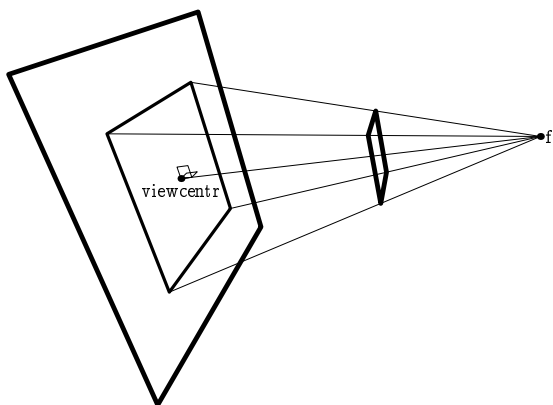

thethreekindsofperspec.2

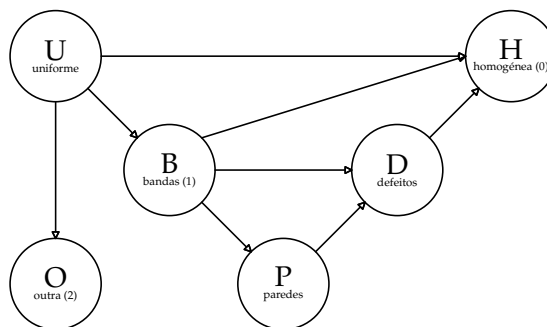

tiposdetransb.1

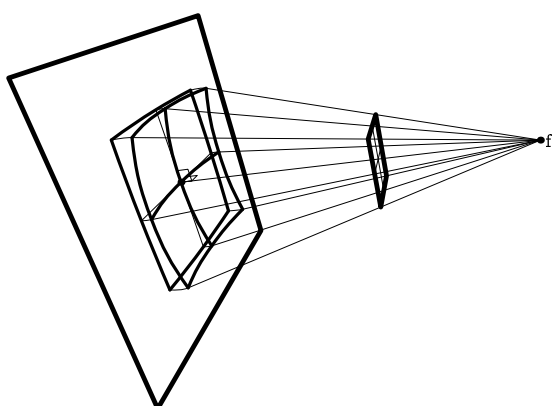

thethreekindsofperspec.3

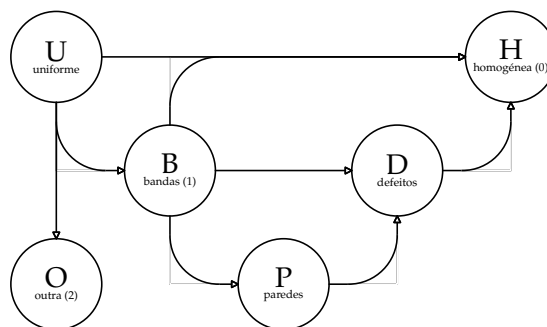

tiposdetrans.1

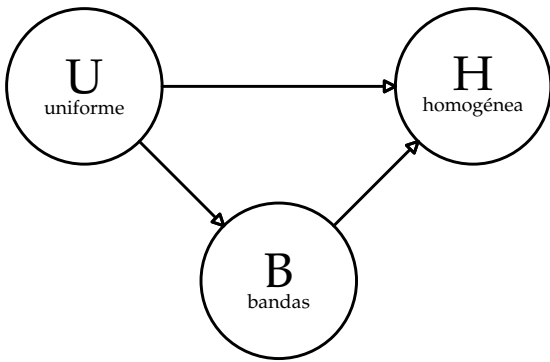

tiposdetranst.1

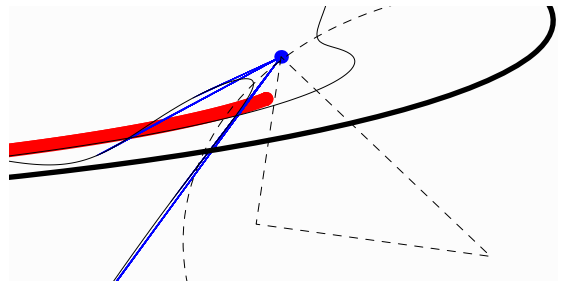

torusexperiment.2

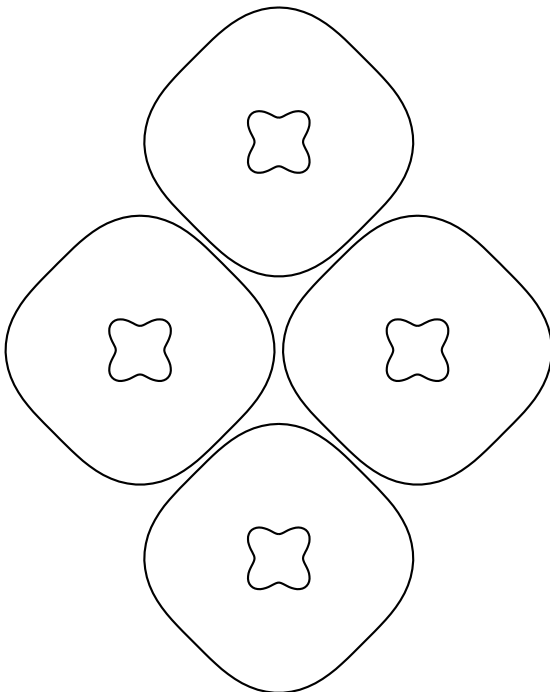

toro4transit.1

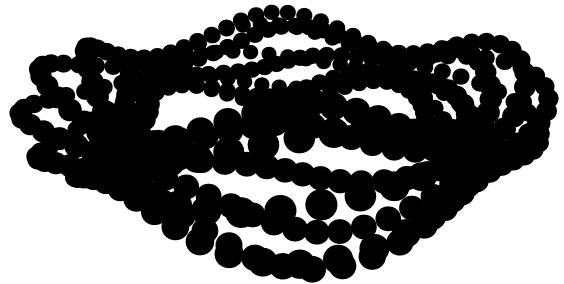

torus.1

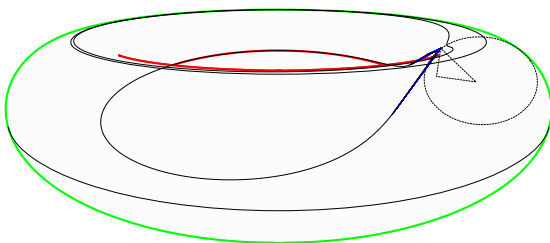

torusexperiment.1

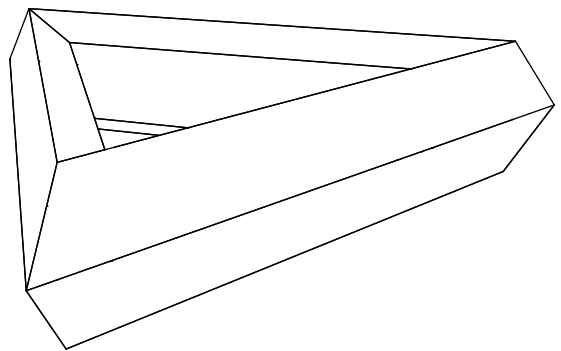

torus.2

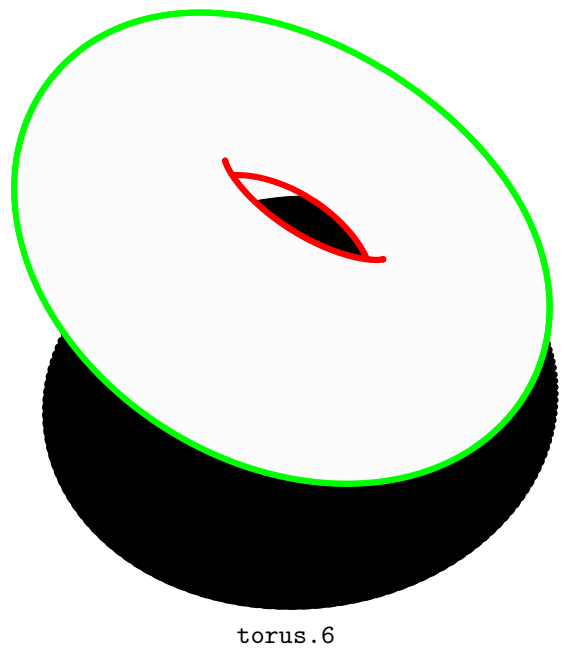
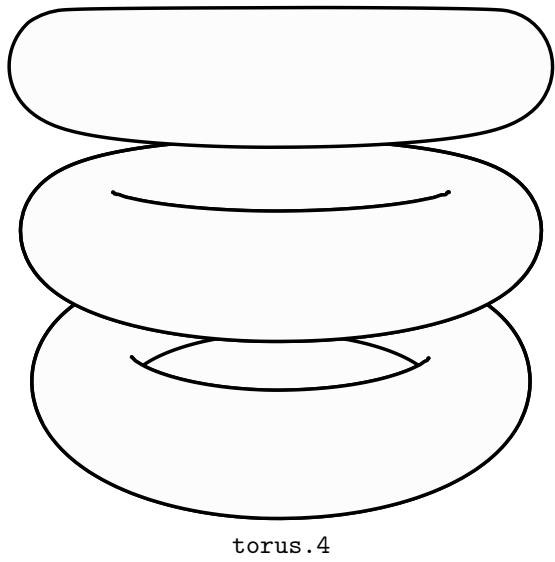
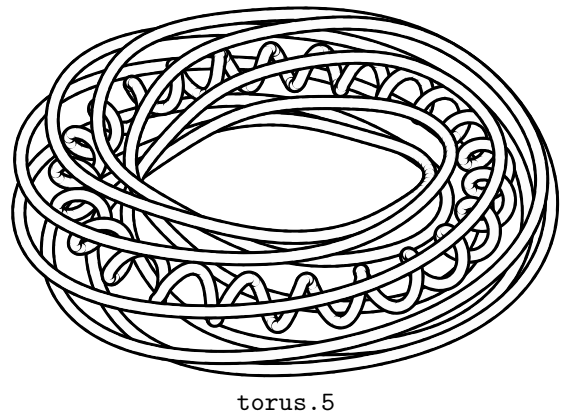
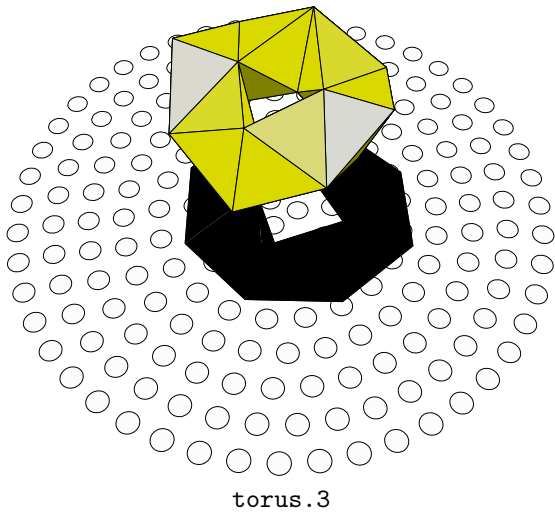

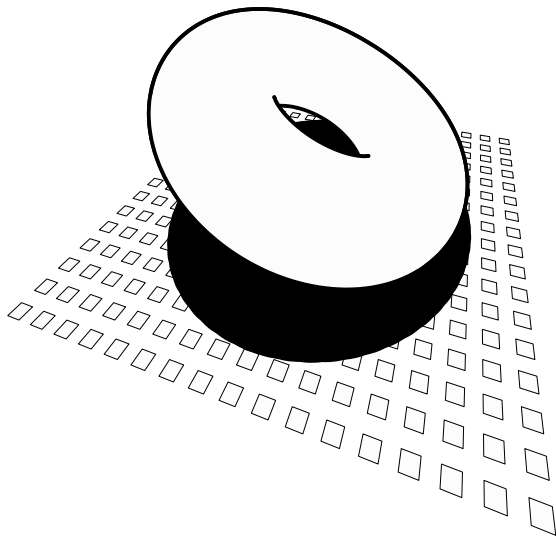

torus.7

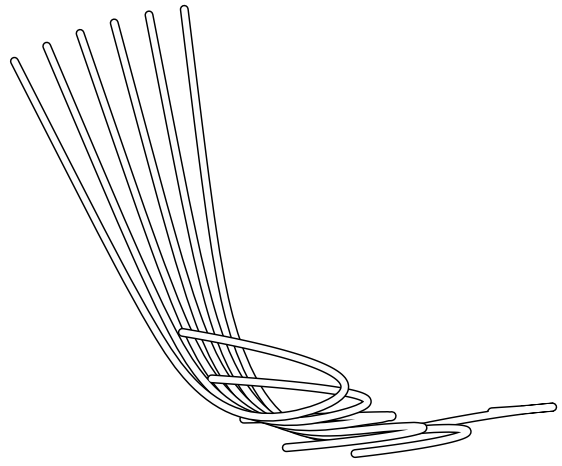

•  
trajectoryline.2

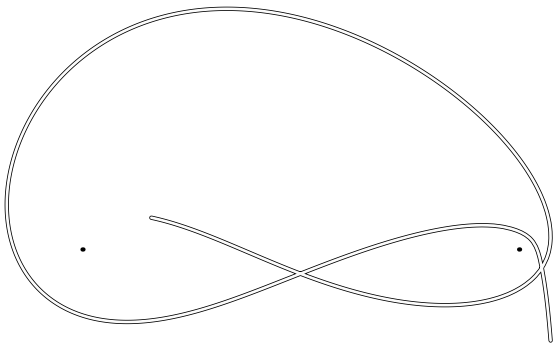

trajectoryline.1

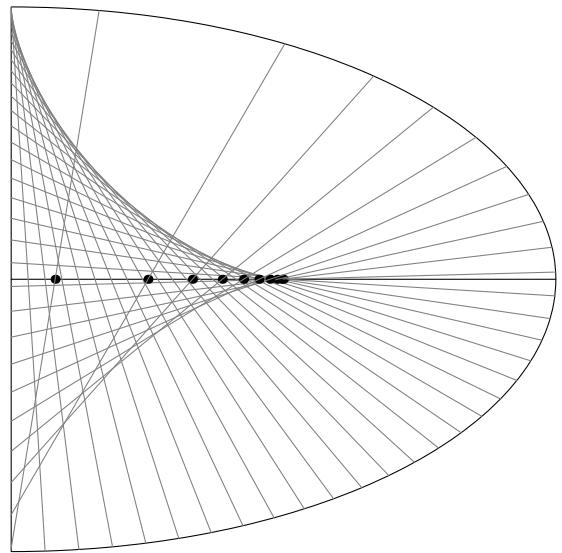

trebuchet.1

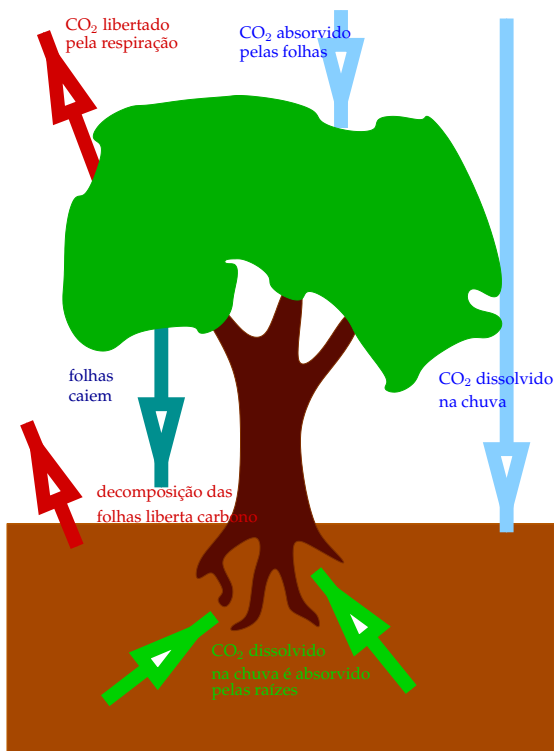

treecarbonedited.0

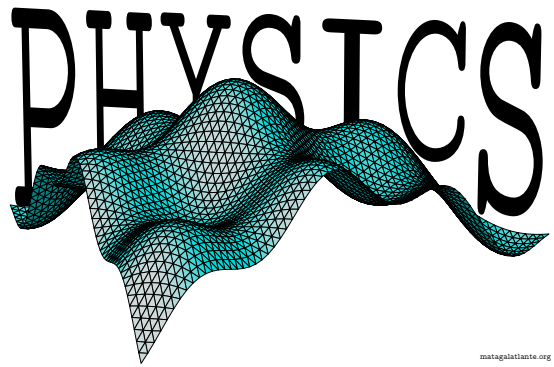

matagalante.org

triangulartrimesh.1

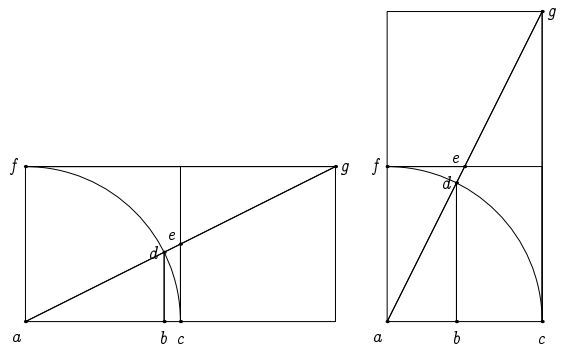

trig.1

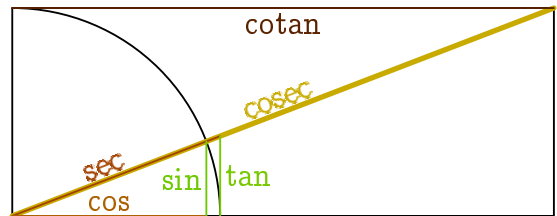

trigonometry.1

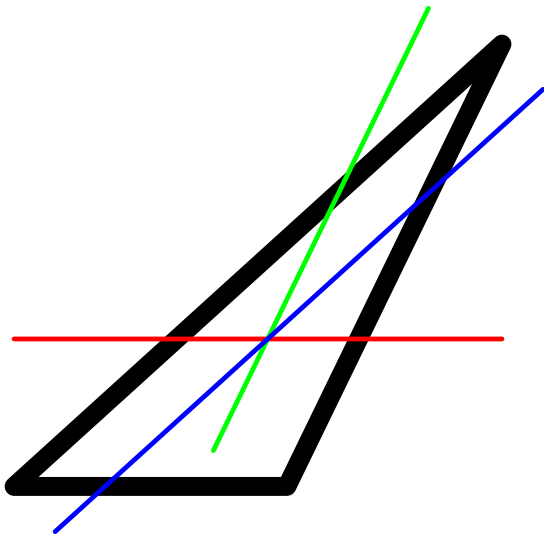

trianglecenterofmass.1

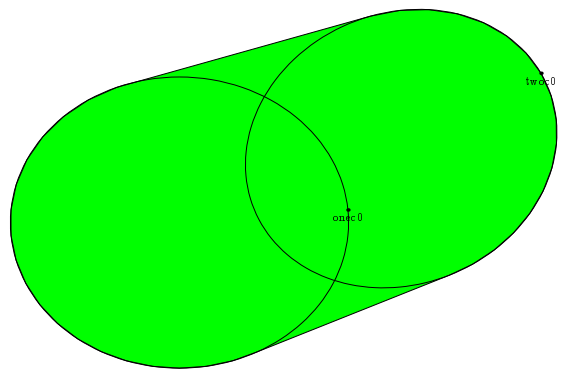

troncoconedef.0

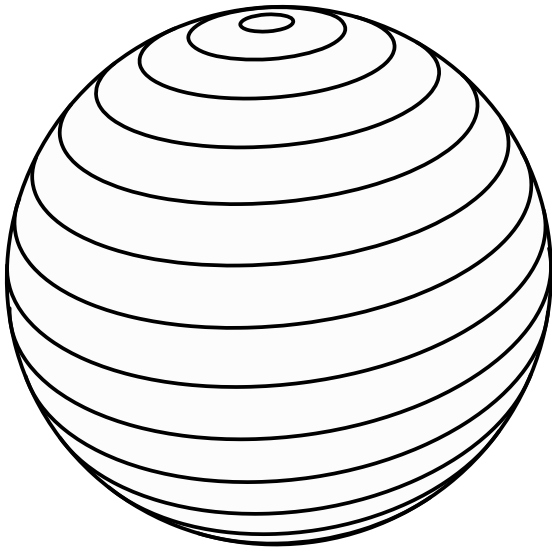

tropicalglobe.1

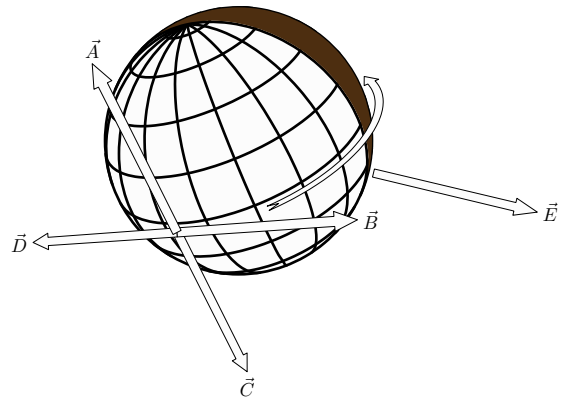

tropicalglobe.3

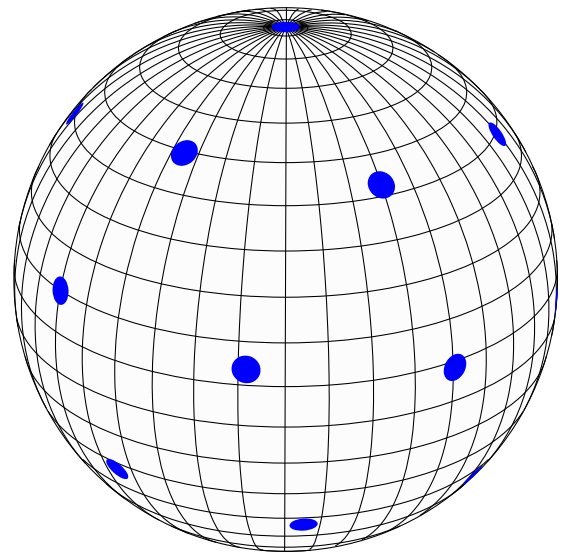

troysfear.1

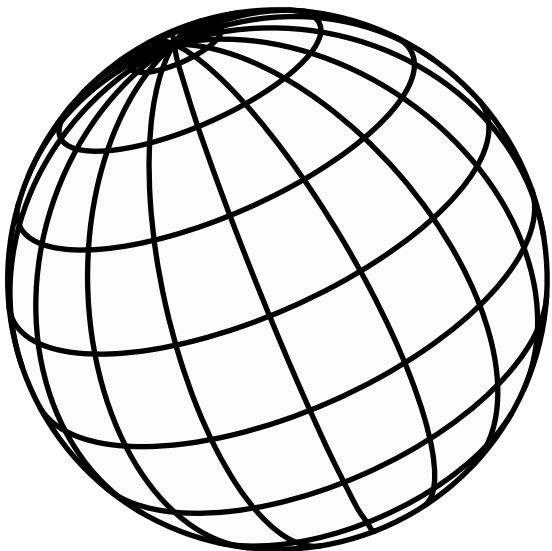

tropicalglobe.2

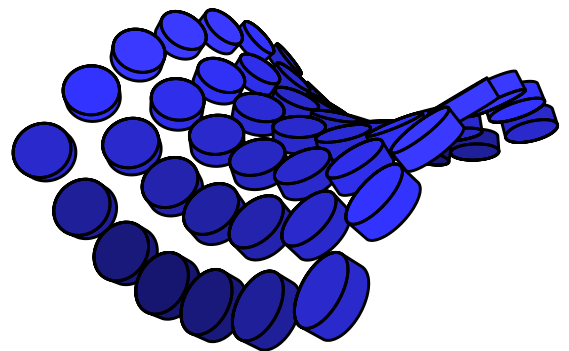

tshirtfig.1

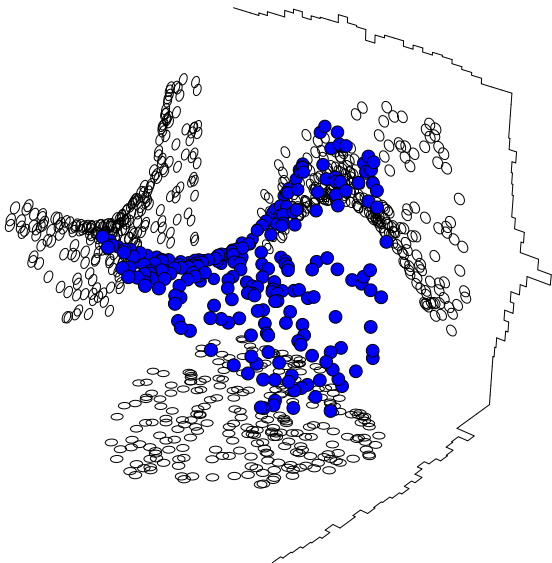

tuftescatter.1

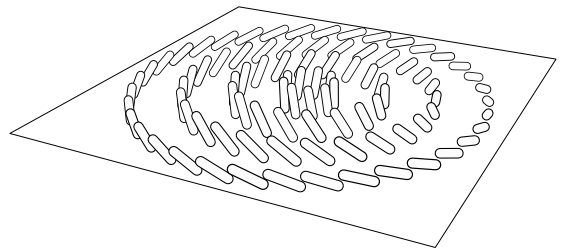

twistroundbiax.1

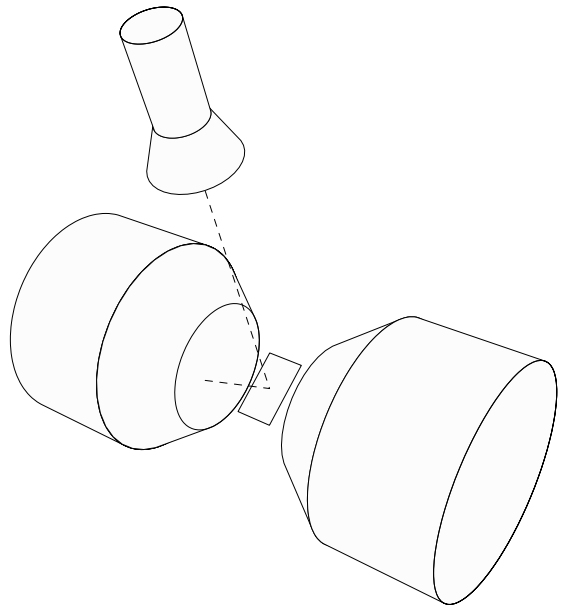

twocyclestogether.1

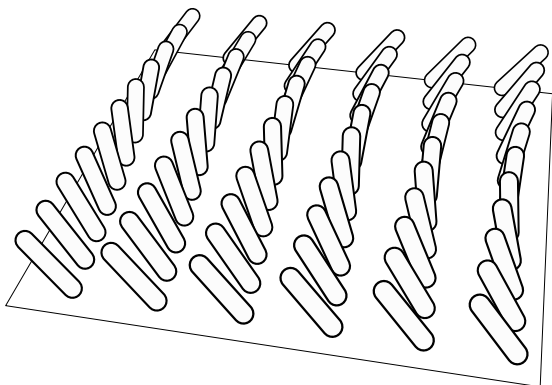

twistflat.1

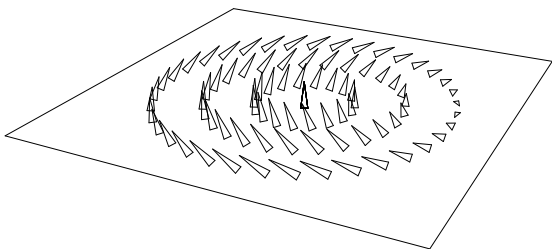

twistnlc.1

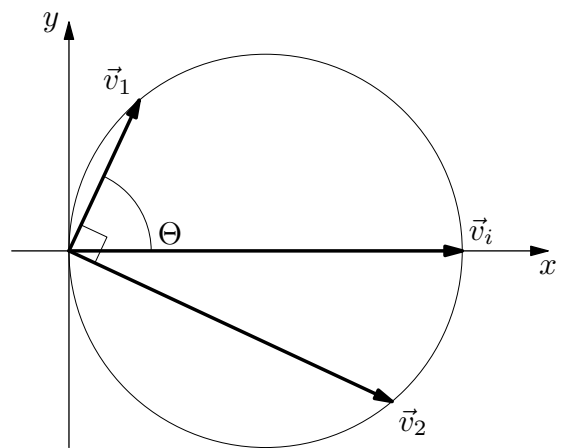

twoDcolision.1



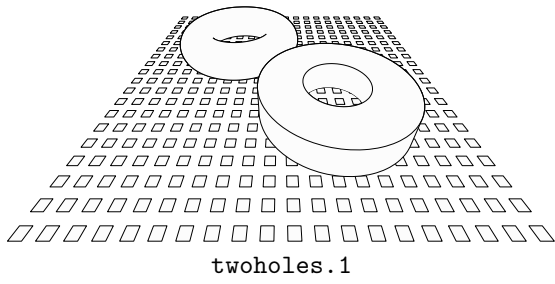

twoholes.1

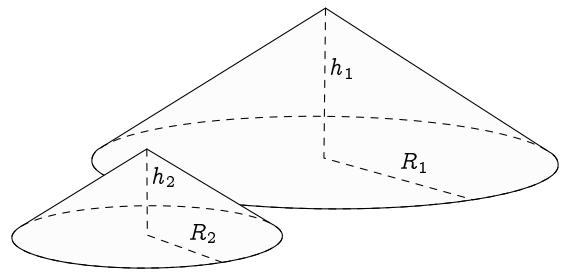

twoupcones.1



twoplustwo.1

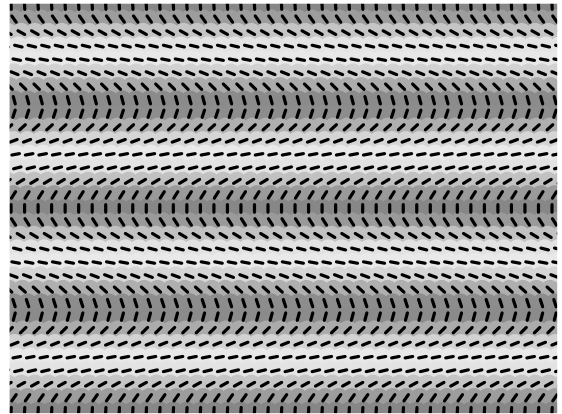

ubhtransients.0

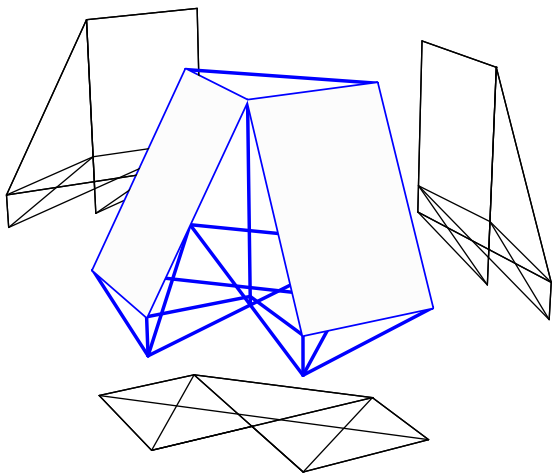

twosolarpanels.1

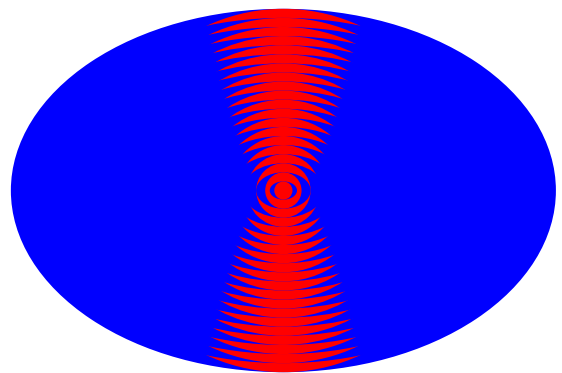

ultraeye.1

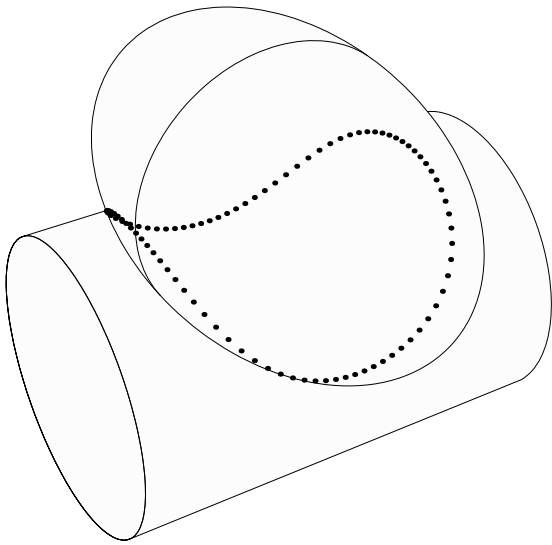

ultraimprovertex.1

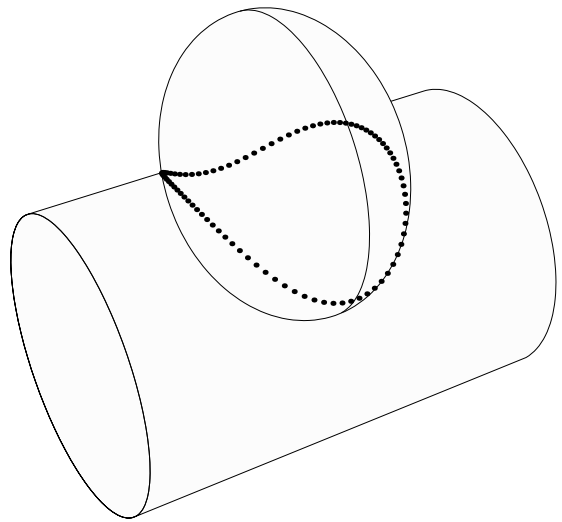

ultraimprovertex.3

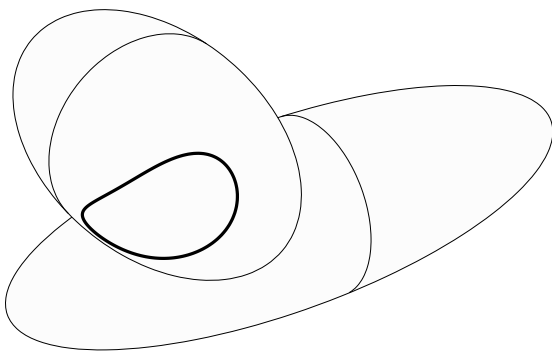

ultraimprovertex.2

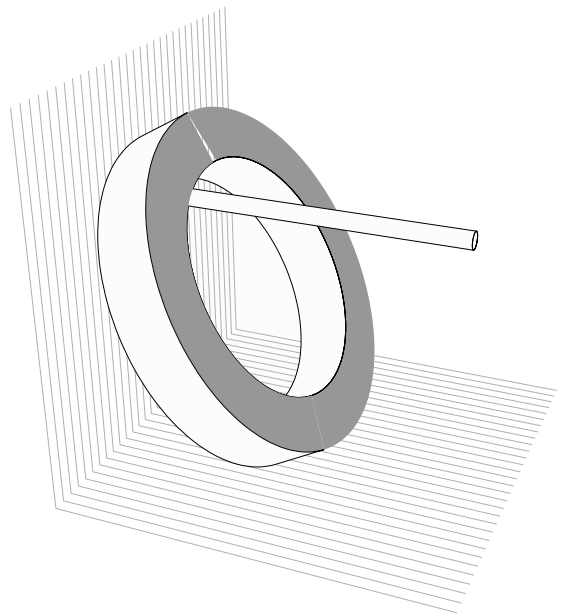

unperfection.1

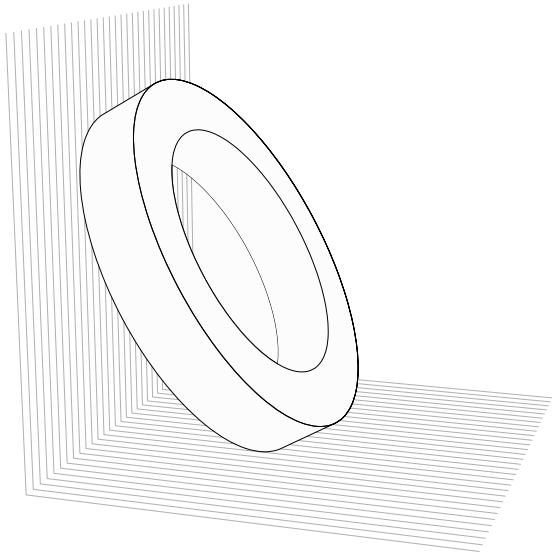

unperfectionremoved.1

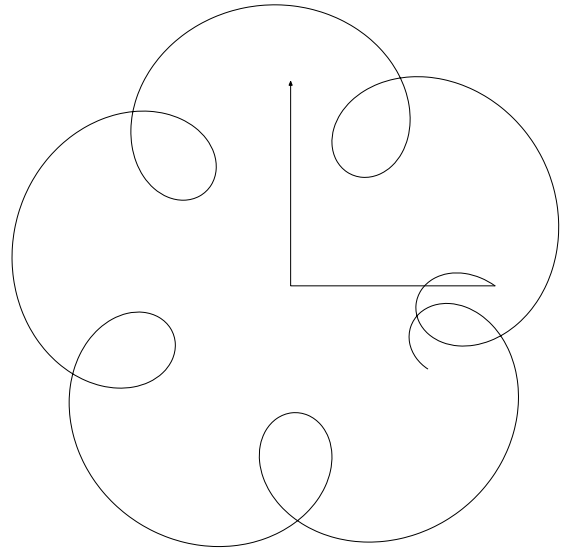

vanallenbelt.2

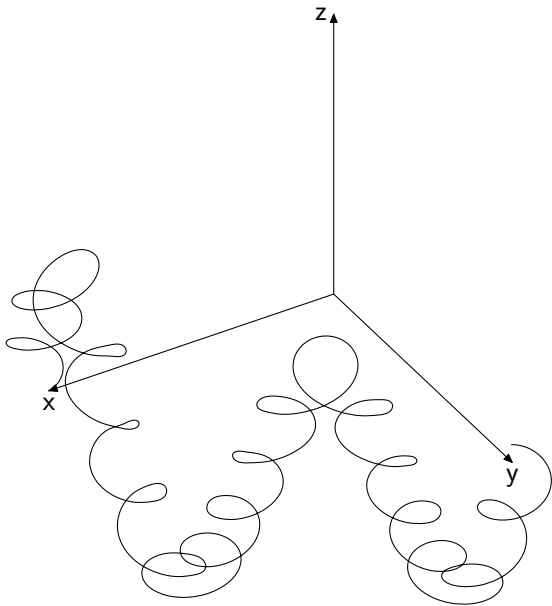

vanallenbelt.1

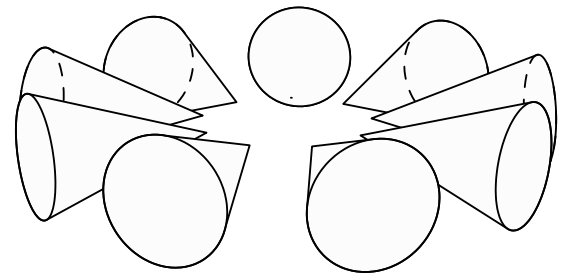

verygoodcone.1

